

FlavourSpec[®]25 with PAL3-RSI



Quickstart Manual



**G.A.S. Gesellschaft für
analytische Sensorsysteme mbH**

FlavourSpec®25 - Quickstart Manual

Version 1.05, June 2025

Valid from FlavourSpec®25 Firmware Version 4.60 in combination with auto sampler PAL3-RSI Series II

All data, texts, designs, images and other elements used in this user manual are protected by copyright law. Any infringement may be subject to legal action.

Passing it on to third parties and producing copies of any kind or form – on the whole or in parts - is not permitted without written agreement of G.A.S. Any infringement may be subject to legal action.

G.A.S. reserves the right to realize technical changes to the product without explicitly mentioning them.

CE-Marking according to:

International Standard EN ISO 17050-1:2004

European Union Low Voltage Directive 2006/95/EC

European Union Electromagnetic Compatibility Directive 2004/108/EC

© Copyright 2025

**G.A.S. Gesellschaft für analytische Sensorsysteme mbH
44227 Dortmund - Germany**

All Rights Reserved.

**G.A.S. Gesellschaft für analytische Sensorsysteme mbH
Otto-Hahn-Str. 15
D-44227 Dortmund
Germany**

**Phone: (+49) 231/9742-6550
Fax.: (+49) 231/9742-6555
E-Mail: support@gas-dortmund.de
Internet: www.gas-dortmund.de**

Table of Content

1	General Information	5
1.1	Information about the Manual	5
1.2	Explanation of Symbols	5
1.3	Notation for dialogs, elements and references	6
1.4	Scope of Supply	7
1.5	Liability and Guarantee.....	13
1.6	Copyright.....	14
1.7	Return and Disposal	14
1.8	Software Updates	14
1.9	Customer Service	14
2	Safety.....	15
2.1	Intended Use Only.....	15
2.2	Responsibility of Operator	15
2.3	Requirements of Personnel	16
2.4	Dangers.....	16
3	Transport, Packing and Storage	18
3.1	Inspection after Transport.....	18
3.2	Packing.....	18
3.3	Storage and Transport.....	18
4	Cleaning and Maintenance	19
4.1	Cleaning	19
4.2	Maintenance.....	19
5	Installation FlavourSpec Device.....	20
5.1	Installation Requirements	20
5.2	Unpack the device.....	22
5.3	Unpack the accessories	25
5.4	Mount the Safety guard	27
5.5	Connect the PAL RSI Terminal	28
5.6	Check the Preinstalled Connecting Cable	29
5.7	Connect the Gas Supply.....	30
5.8	Connect the Power Supply	35
5.9	Remove the Transport Lock	37
5.10	Complete the Device.....	38

FlavourSpec®25 - Quickstart Manual

5.11	Switch on the Device.....	38
5.12	Check essential device position.....	39
5.13	Prepare the device for operation.....	40
6	System Operation.....	44
6.1	Measurement Requirements.....	44
6.2	Workflow: Check Injector Position.....	45
6.3	Workflow: Check Agitator Position.....	48
6.4	Workflow: Check Tray Reference Position.....	52
6.5	Workflow: Run a measurement with autosampler.....	57
6.6	Workflow: Run a measurement with manual injection.....	61
7	Appendix.....	64
7.1.1	IMS-Spectrum Examples.....	64
7.2	Corresponding G.A.S. Documents and Tutorials.....	66

1 General Information

1.1 Information about the Manual



INFORMATION!

This **Quickstart User Manual** is an excerpt of the most important information for installation and initial setup from the User Manual. It is an **addition to the User Manual** and does not replace the User Manual.

This manual describes a safe and adequate handling of the device. Following the instructions of the indicated safety aspects and instructions as well as the national and/or local rules and general safety regulations concerning the prevention of accidents are absolutely imperative.

Before starting the work with the device read the manual completely and thoroughly particularly the chapter security and respective safety references. Assure that you/the operator comprehend the terms described.

The manual is part of the device. It must be stored together with and next to the device at any time.

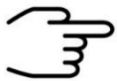

INFORMATION!

The graphics in this user manual are schematic and may differ from the actual conditions. The firmware and PC software screenshots in this user manual may differ from the actual conditions.

1.2 Explanation of Symbols

Important and safety-relevant references in this manual are characterized by symbols. These indications which are in-line with industrial safety must be respected and followed at any time.



INFORMATION

This symbol calls information, which are to be considered for efficient and perfect handling of the equipment.



WARNING

This symbol indicates references, which can lead to damages, malfunctioning and/or loss of the device.



DANGER

This symbol marks references, which can lead to health impairments, injuries, lasting body damages or to death due to electric current.



DANGER

This Symbol marks paragraphs, which describe potential dangers and damage due to exposure to radioactive radiation.



DANGER

This symbol marks paragraphs, which describe situations in which surface parts of the device can heat up to a point where touching it or bringing objects close to it may be hazardous.

1.3 Notation for dialogs, elements and references

Example Dialog:

System > **Connections** > **LAN File Transfer** > **Settings...** > **Test Connection**

Example Elements:

Gas Out, **Sample gas in**

Example: References

Advanced User Manual, **Chapter 5.1 Installation Requirements**

Example: Information

keep the transport box

1.4 Scope of Supply

Assure that you have received the full scope of supply. If there is any part missing, please contact the GAS-hotline immediately.

FlavourSpec Scope of Supply



FlavourSpec Device coupled Autosampler PAL3 Series II



**FlavourSpec Power supply with cable
(1 piece)**



FlavourSpec Gas tube Kit

- Driftgas/Carriergas (1 piece)
- 2 m 3 mm PFA Tubes with 3 mm Swagelok-Connector (2 Pieces)
- 0,65 m 3 mm PFA Tubes with 3 mm Swagelok-Connector (1 Pieces)

FlavourSpec®25 - Quickstart Manual



Molecular sieve 200 mL with 1/8" connections (1 piece) with holder (different designs)



LAN Cable (1 piece)



FlavourSpec-PAL3 Connection Cable (1 piece)



FlavourSpec Blind plug Set (4 pieces)

(Swagelok 3 mm Blind plug with red cap installed on device connectors)

Autosampler PAL3 Series II Scope of Supply



Autosampler Power supply with cable
(1 piece)



Terminal with Connection Cable (1 piece)



Agitator Connection Cable (installed)
(1piece)



PAL3 Torx Tool Kit

- Torx Screwdriver 8 mm (1 piece)
- Torx Screwdriver 10 mm (1 piece)
- Torx Screwdriver 20 mm (1 piece)
- Torx Screwdriver 25 mm (1 piece)

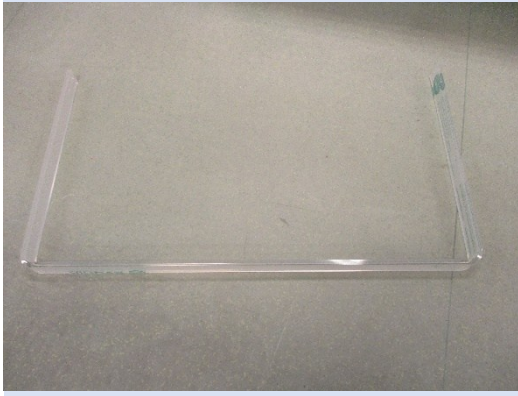

Safety Guard including screws (1 piece)



Syringe Kit (2 pieces)

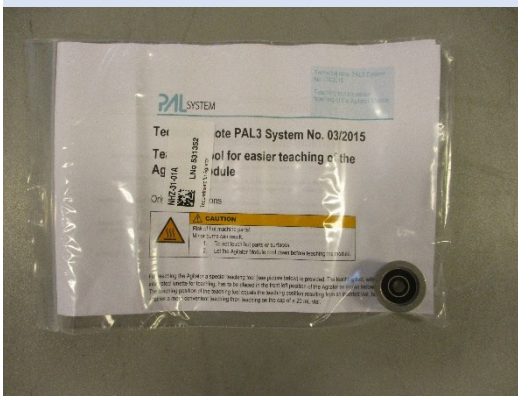

PAL3 Teaching Tool



Starter Kit

(100 x 20 ml Headspace Vials, 100 magnetic caps, 3 Septa for Injector)

FlavourSpec®25 - Quickstart Manual

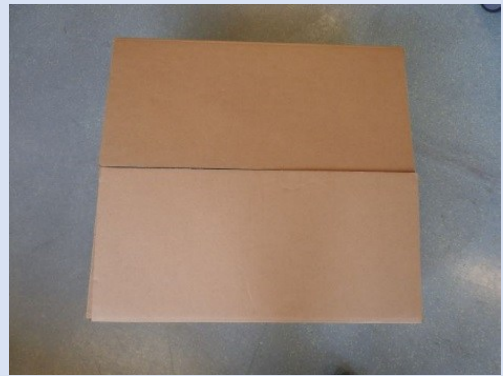

Transport box (1 piece)

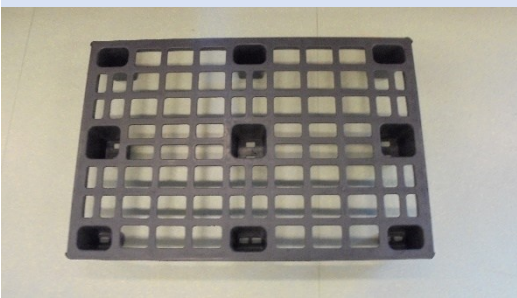

FlavourSpec Transport palett (120 x 80 cm)

Optional Scope of Supply (only available if ordered)



Nitrogen Generator with accessories (example picture)



Laptop Computer (different design) including software for control and evaluation

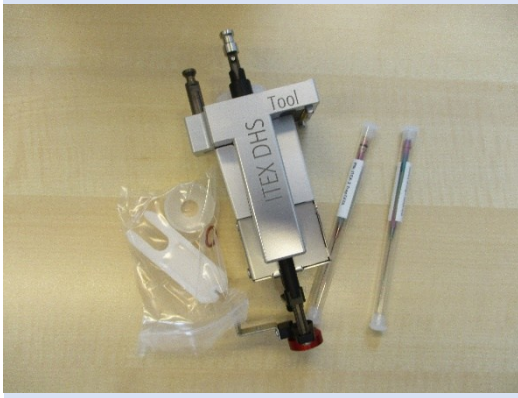

PAL ITEX-Kit



Crimper for H 20 ml Headspace Vials

1.5 Liability and Guarantee

This user manual describes the safe and proper handling of the device.

All data and reference within this manual are compiled under the valid regulations, the state-of-the-art as well as G.A.S. experiences of several years.

This user manual must be stored together with and close to the device at any time and accessible to all persons, who operate or handle the device at any time.

This user manual must be read carefully before starting to work with the device. G.A.S. does not assume any liability for damage and disturbances, resulting from disregard of the instructions contained in this user manual. All claims of any kind related to damage from a not intended use of the device will be rejected.

G.A.S. reserves the right to realize technical changes of the product due to improvements without explicitly mentioning them.

1.6 Copyright

The manual is confidential. It is beyond doubt exclusively made and also meant for the personnel directly dealing with the equipment. All data, texts, designs, pictures and other representations within this manual are protected in the sense of the copyright law and are subject to further commercial patent rights. Each abusive is punishable by law.

Passing it on to third persons as well as duplications in any kind and form - also in part - as well as the use and/or report of contents are not permitted without written agreement of the manufacturer. Offences lead to payment of damages. We reserve ourselves all rights of the practice of commercial patent rights.

1.7 Return and Disposal

For an adequate disposal, the device or/and its equipment must be returned to the G.A.S. or to a third party authorized by the G.A.S.! For questions please contact G.A.S.

1.8 Software Updates

If there are any software updates customers will be contacted by G.A.S. Gesellschaft für analytische Sensorsysteme mbH as soon as the updates are available. The updates are free of charge within the first 12 month after delivery. Users will be provided with information about the changes and instructions for executing the updates.

1.9 Customer Service

For questions concerning G.A.S. products a customer service is available:

G.A.S. Gesellschaft für analytische Sensorsysteme mbH

Otto-Hahn-Straße 15

44227 Dortmund

Germany

Phone: +49 (0) 231 / 97 42 - 65 50

Fax: +49 (0) 231 / 97 42 - 65 55

support@gas-dortmund.de

The telephone hotline is available from monday to friday from 9:00 to 16:00 hours. In urgent cases or if you use fax or email please provide a telephone number for callbacks

2 Safety

2.1 Intended Use Only



WARNING!

Usage other than described in this manual may damage the device and/or harm persons involved.

Do not use the device for other purposes. Damages due to misuse are not covered by the guarantee. Such damage claims will be rejected.

The device and its equipment are not certified for the employment in areas with explosive gas air mixtures.

All claims or requirements of any kind against the manufacturer and/or its authorized persons that arise due to damages from a not intended use of the device will be rejected. All damages that arise from a not intended use are of the operator's responsibility.

The intended use of the equipment and its correct handling according are described in the operating instructions of this manual. Other parts than the parts belonging to the scope of supply, may only be used after G.A.S. approval.

2.2 Responsibility of Operator

The device may only be operated in a perfect technical condition. Before putting the device into operation the condition of the device and its equipment must be checked. The information and instructions provided in this manual have to be followed at any time.

Besides the instructions provided in this manual the local rules for the prevention of accidents, general safety regulations - valid for the area of application of the device - as well as the valid environmental-protection regulations must be considered and respected.

The responsible technicians and operators have to make sure a failure-free use of the device. Responsibilities among the involved persons regarding installation, operation, maintenance and cleaning must be made clear.

2.3 Requirements of Personnel

Only authorized and trained technical personnel may work with the instruments. The operator must have received an instruction over existing and all possible dangers and should be regularly instructed in safety procedures and environmental protection and that the personnel is fully aware of the complete operating instructions and particularly the safety notes. Personnel that might be under the influence of drugs or alcohol are to be kept off the device at any time.

Technical personnel in this context are defined as skilled employees who are knowledgeable due to their educational background. In case the foreseen personnel do not have the necessary qualifications to operate the instrument, it must be trained. Further to that non-authorized personnel should not operate the device.

The competencies for the work on and with the device must be specified and kept undoubtedly at any time so that with respect to security issues no unclear situation might come up.

Any changes of the equipment, which impair security of the personnel, must immediately be reported to the operator and every person dealing with it.

2.4 Dangers

The device and its equipment is subject to an endangerment analysis. The construction and execution of the device corresponds to the today's state-of-the-art. The device is reliable in service when operated according to its intended use.



INFORMATION!

If the housing of the device is damaged, the device must not be used anymore and must be returned to the G.A.S. by using the original transportation case.



DANGER

The FlavourSpec® device contains a radioactive radiation Tritium source which in all EURATOM countries is below the exemption limit of 1 GBq for tritium acc. to Table B (column 2) of Article 26, of the Directive 2013/59 EURATOM of December 5th, 2013.

However, do not open the device! Do not try to recover malfunctions of the device! Malfunction recovery, repairs and any maintenance work may only be performed by G.A.S. or by qualified personnel authorized by G.A.S.



DANGER

The FlavourSpec® and its equipment is not certified for the employment in areas with explosive gas air mixtures (Zone 0).



DANGER

Exercise great care in handling current-carrying parts like the power supply cord. Do not get directly in touch with current-carrying parts. Do not open the housing. Do not use damaged parts.



DANGER

When Nitrogen is used as drift gas and helium as carrier gas, ignition of a helium plasma may occur due to the high voltage present in conjunction with a radiation source. This can damage the IMS.



DANGER

This symbol marks paragraphs, which describe situations in which surface parts of the device can heat up to a point where touching it or bringing objects close to it may be hazardous.

3 Transport, Packing and Storage

3.1 Inspection after Transport

Check the supply immediately after delivery concerning its completeness and/or transport damages. If you detect externally visible transport damage, do not receive the supply, or only under reservation. State the extent of the damage on the provided delivery note and/or the transportation documents of the feeder. Generate a complaint. Lodge a complaint of covered defect immediately after recognizing, as claims due to transport damages can only be made valid within the complaint periods (usually 7 days).

3.2 Packing

If no return agreement regarding the packing was agreed upon dispose the packaging material always in an environmentally friendly way and according to valid local regulations. If additional information is required please ask a recycling company.



INFORMATION!

It is recommended to **keep the transport box** for a safe return transport.

3.3 Storage and Transport

Store the device only under the following conditions:

- **When not in use store the equipment in the supplied casing**
- **Prevent unauthorized access**
- **Do not store outside**
- **Protect the equipment from moisture and dust**
- **Put protective caps on all gas sockets**
- **Avoid mechanical vibrations**
- **Do not expose the equipment to aggressive substances**
- **Protect the equipment from direct sun light**

- **Storage temperature: 5 to 40 °C**
- **Relative Air Humidity: 0- 90% RH, prevent condensation**
- **Instrument's position: Horizontal**

The equipment should be moved only packaged into the provided transport case. By these means, transport damages can be avoided. The above-mentioned values are considered for an instrument transported in its original new packing.



WARNING!

Protective caps should be put on gas sockets in case the device is stored or transported.

4 Cleaning and Maintenance

Natural aging and the wear of certain components of the equipment require a regular cleaning and maintenance.

4.1 Cleaning

Clean the device only with a dry or easily damp cloth.



WARNING!

Do not use cleaning agents, which contain solvents, acids, or bases.

4.2 Maintenance

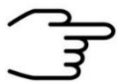

INFORMATION!

Maintenance of the device should only be carried out at G.A.S. or through specially trained and by G.A.S. authorized personnel.

The recommended **maintenance interval is 24 months**.

5 Installation FlavourSpec Device

5.1 Installation Requirements

The following requirements must be fulfilled by the customer:

Location of Installation

- Available space of 1000 x 900 x 800 mm (W x D x H)
- Ambient temperature of 5 – 40 °C
- Humidity: 0-90% RH, non-condensing
- Robust table with a minimum carrying capacity of >40 kg

Electricity

- Electricity supply free of interferences
- Power Supply of 230 V \pm 10%, 50- 60 Hz \pm 1%

Gas supply

- Nitrogen (Quality 5.0 (99,999%) or Synthetic Air (Quality 5.0 (99,999%))
- Stainless steel pressure reducer with 3mm or 1/8" Swagelok-Connector adjustable pressure range of 3 – 6 bar and 3 mm Swagelok connector

Safety

- Availability of exhaust system for device exhaust gas tubes (Gas out and Sample Gas out)

Computer

- Computer with current Microsoft Windows operating system
- Administrator right to install G.A.S. software

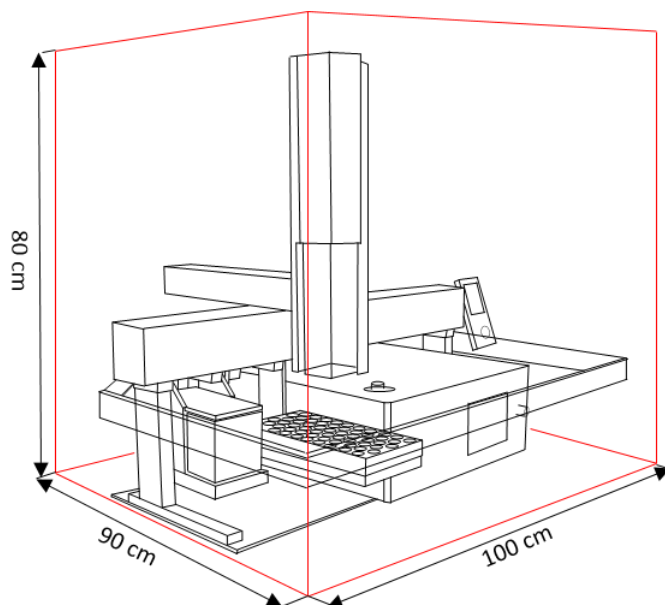

Figure 1: Space requirement FlavourSpec with Autosampler PAL RSI



INFORMATION!

To ensure correct measurements it is absolutely necessary to **connect the supplied exhaust tubes** (Gas out and Sample gas out).

The exhaust tubes (Gas out and Sample gas out) **must be led separately into the exhaust system and must not be connected.**

The exhaust system must **not generate any negative pressure.**

5.2 Unpack the device



At least two people are necessary to unpack the device.

1

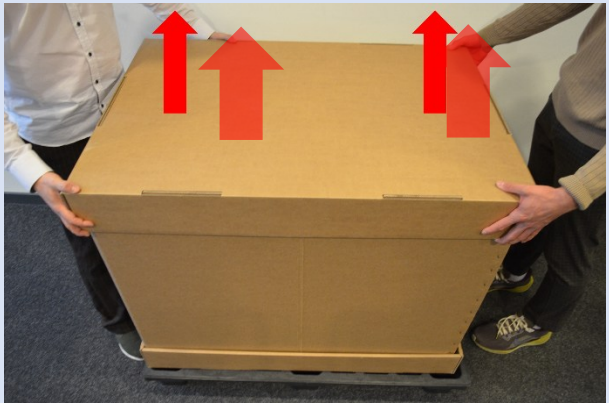

Remove the cover.

2

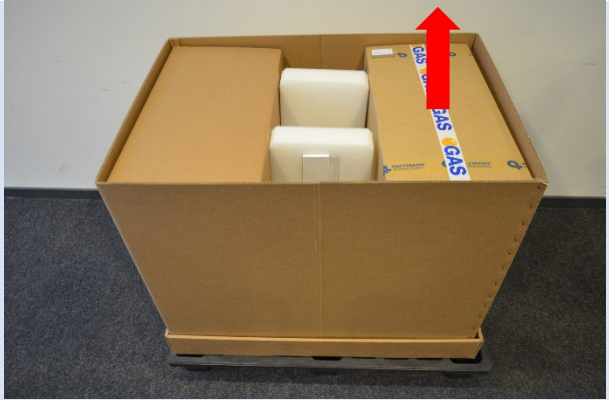

Remove the accessory box.

3

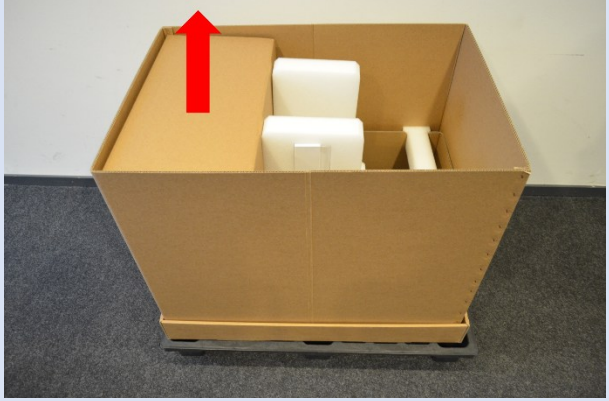

Remove the cardboard spacer..

4

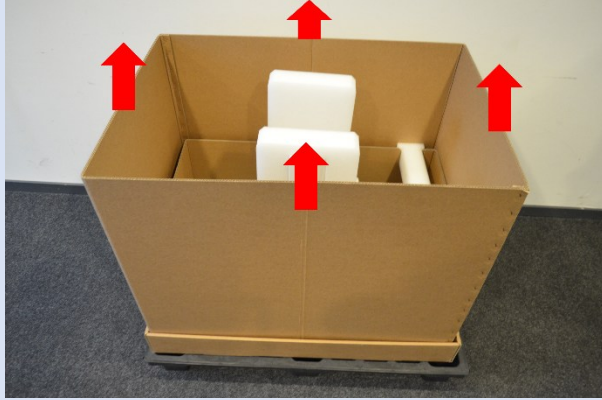

Remove the outer transport cover

5



Remove the right foam spacer.

6

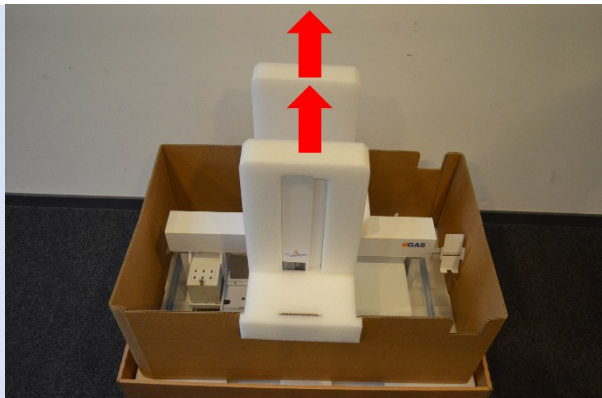

Remove both foam spacers.

7

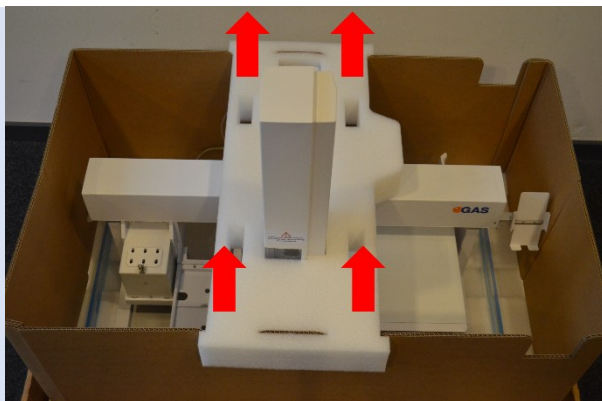

Remove the middle foam spacer.

8

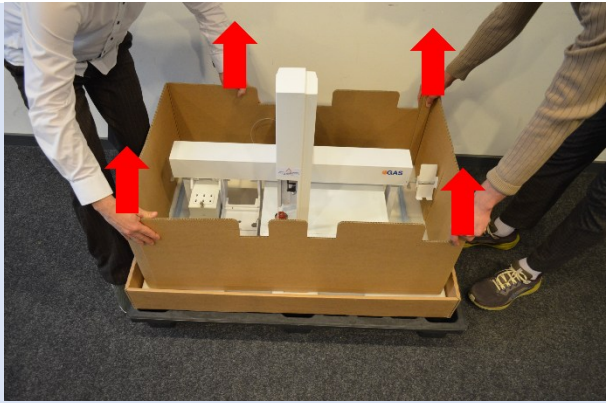

Remove the inner transport cover

9

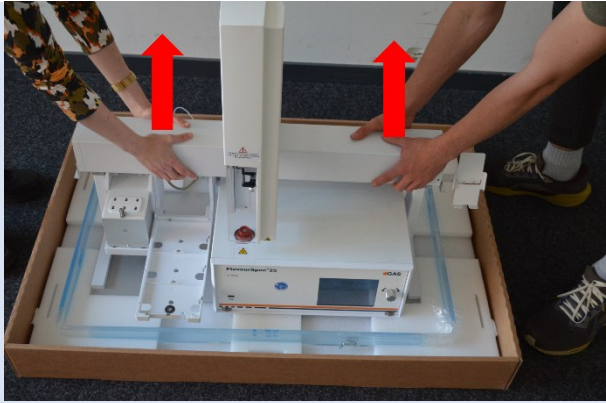

Lift the device carefully.



WARNING!
The arm of the autosampler can move freely. It is recommended to hold the arm by a third person.

10

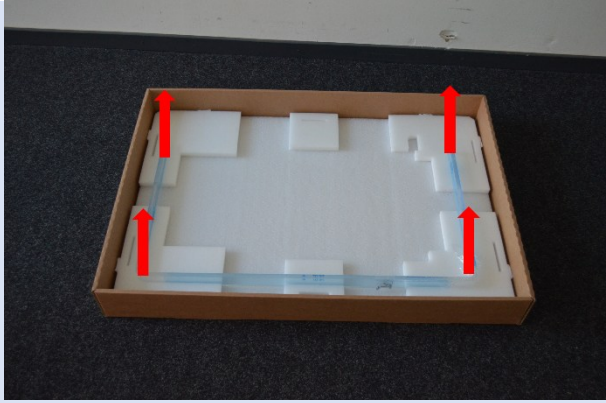

Take the safety guard out.

11

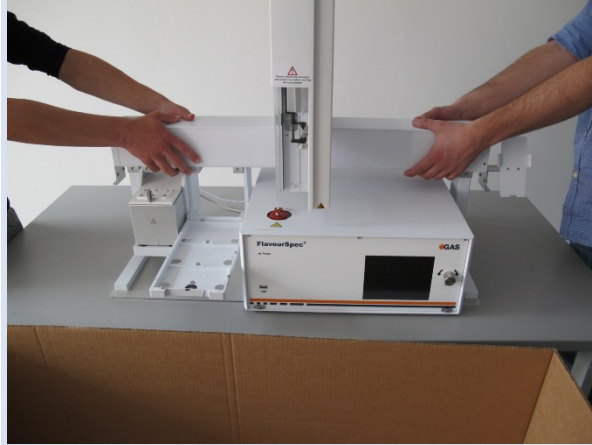

Put the device on a stable table.

12

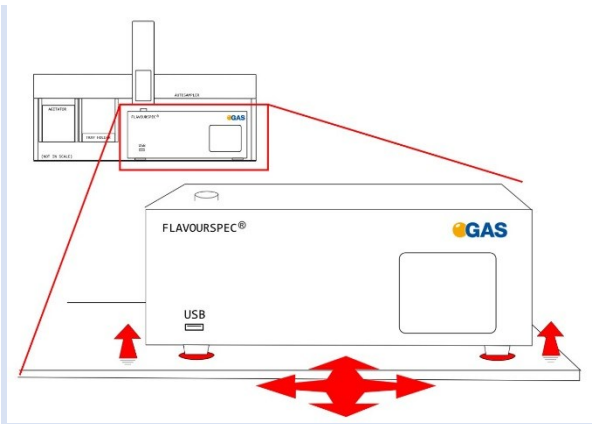

Check the position of the instrument feet.

The instrument feet and the position holes of the baseplate must fit.

5.3 Unpack the accessories

1



- 1** Accessory box
- 2** Packing list

2



The figure shows the opened box.

3

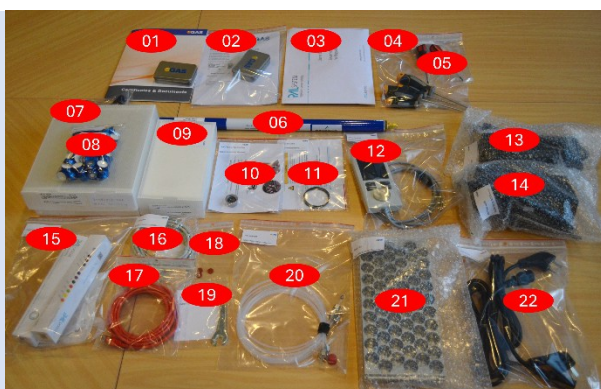

The figure shows the delivered standard components.

Check the entire delivery for completeness on basis of the packing list.

4

- 1** FlavourSpec® documents (printed out and in digital form on the USB-memory stick)
- 2** Custom ketone mix
- 3** Autosampler owner documents CTC
- 4** FlavourSpec® torx screwdrivers
- 5** PAL RSI torx screwdrivers
- 6** Molecular sieve and two holders
- 7** 20 mL headspace vials
- 8** Magnetic caps for headspace vials
- 9** Crimper
- 10** PAL RSI teaching tool
- 11** Agitator replacement belts
- 12** Terminal
- 13** FlavourSpec® power supply
- 14** PAL RSI power supply
- 15** PAL RSI Syringe Kit
- 16** FlavourSpec® LAN cable
- 17** PAL RSI LAN cable
- 18** Septa
- 19** PAL RSI wrenches
- 20** FlavourSpec® Gas Tube Kit
- 21** Tray

22 FlavourSpec® and PAL RSI power cable

5.4 Mount the Safety guard

1



The necessary screws are included.

2

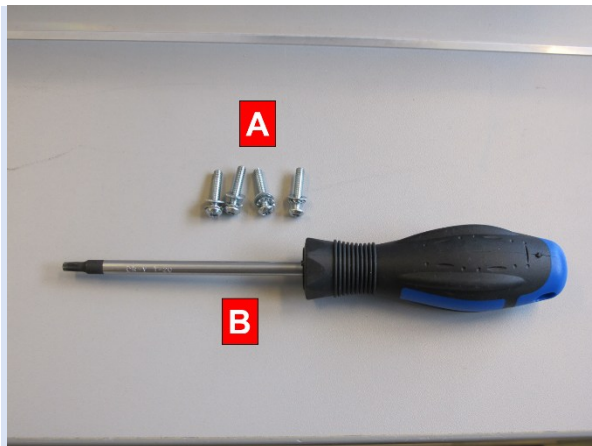

To connect the Safety Guard the following required:
A: four M4 Torx screws with spring washer and washer
B: Screwdriver Torx T20

3

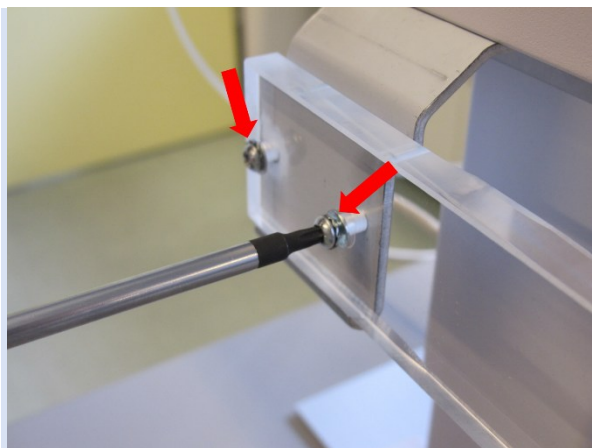

Connect the Safety Guard to the Safety Guard Brackets on the left and ...

FlavourSpec®25 - Quickstart Manual

4

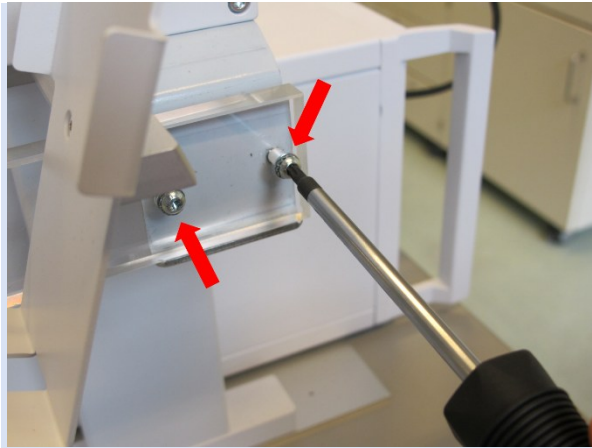

...right side of the X-Axis using the screws.

5



The figure shows the autosampler with installed Safety Guard.

5.5 Connect the PAL RSI Terminal

1



Connect the Terminal cable to the Terminal Connector (green marking).

2



Place the Terminal into the Terminal Holder.

5.6 Check the Preinstalled Connecting Cable

1

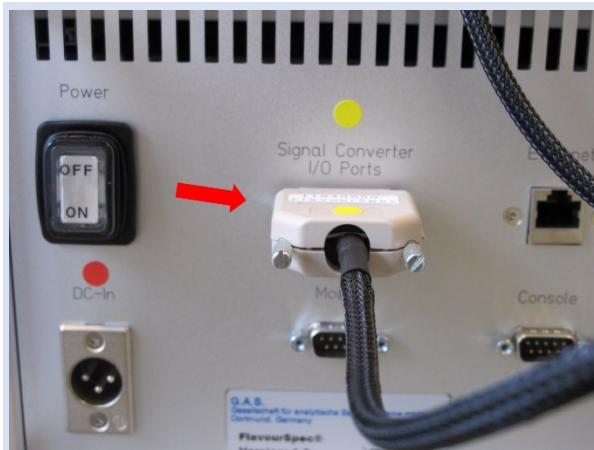

Rear FlavourSpec:
Check the connection cable Autosampler/ FlavourSpec (Grey Plug, Yellow marking) at the Signal Converter I/O Ports

2

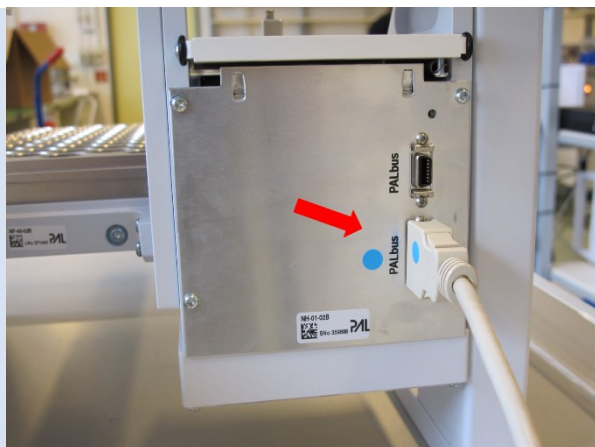

Rear Agitator:
Check the connection cable Agitator (blue marking) at the port PALbus.

3

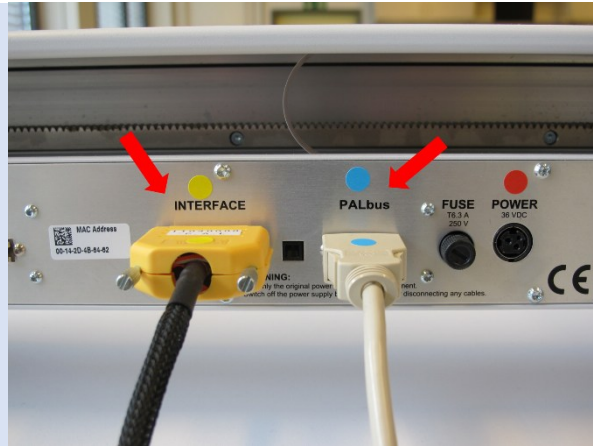

Rear Autosampler X-Axis:

Check the connection cable Agitator (blue marking) at the port PALbus.

Check the connection cable Autosampler/ FlavourSpec (Yellow plug, yellow marking) at port Interface

4

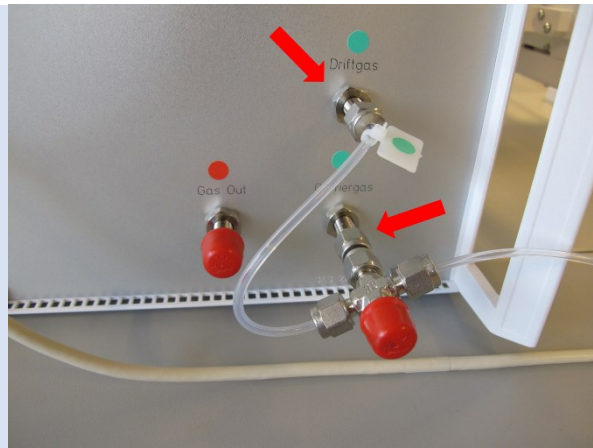

Rear FlavourSpec:

Check the 3 mm Swagelok-Connection of the Driftgas-/Carriergas-Adapter.

5.7 Connect the Gas Supply

1

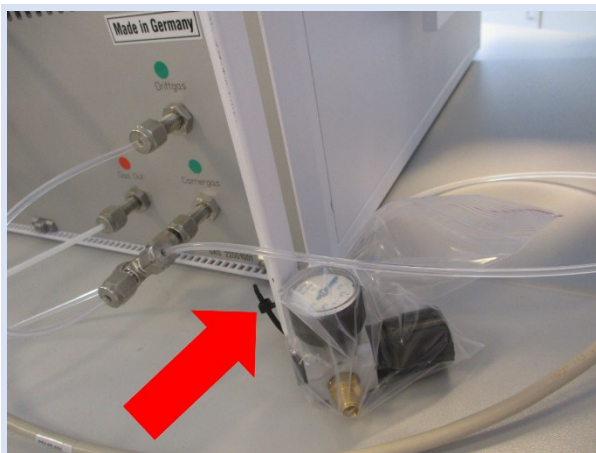

Release the pressure reducer.

2

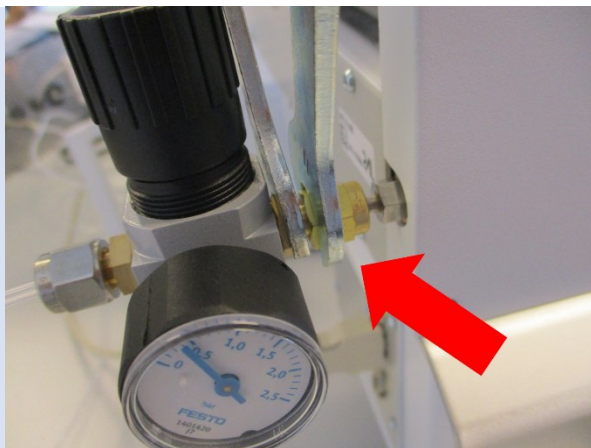

Mount the pressure reducer at the rear of the autosampler.

3

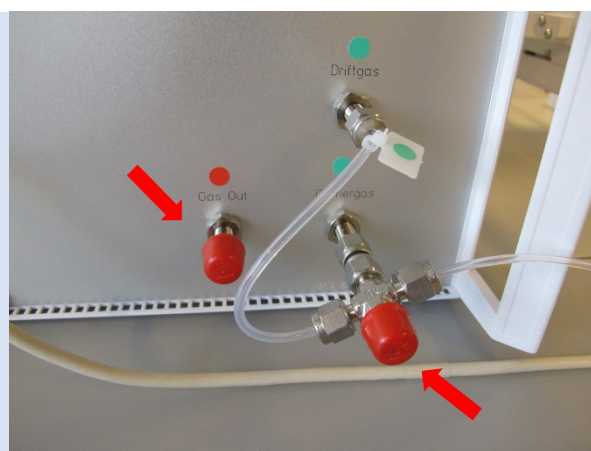

Remove the red caps on the rear panel of the device. **Keep the red caps.**

4

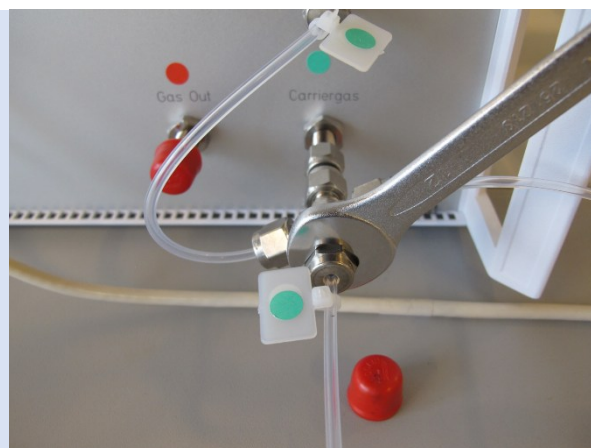

Connect a tube (green marking) with 3 mm Swagelok-connection to the Driftgas/Carriergas-connection using a 12 mm spanner.

5

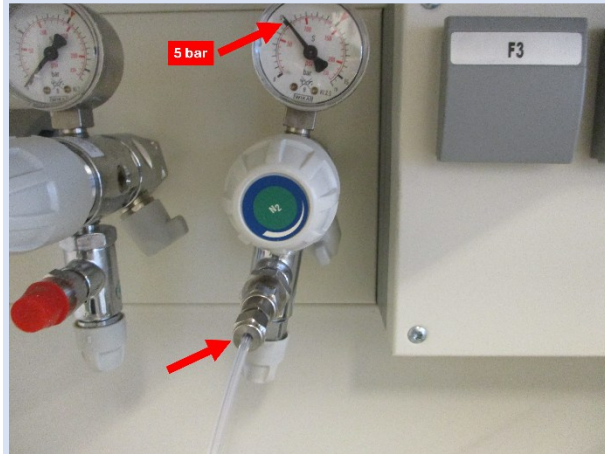

Connect the tube to a nitrogen or synthetic air gas supply. (Gasquality: nitrogen 5.0 or synthetic air 5.0).

Set up the back pressure to 3-6 bar
Recommended 5 bar!

6

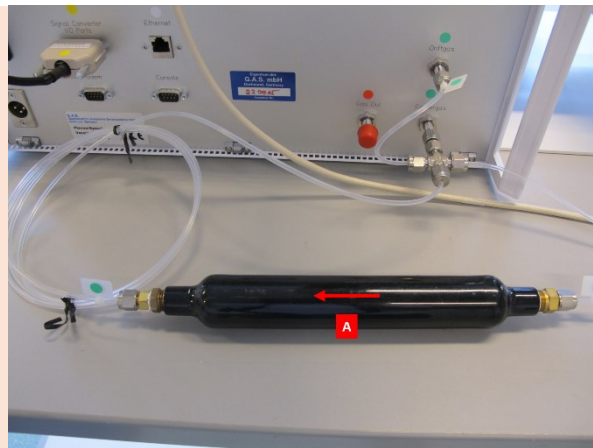

OPTIONAL

To ensure a high purity of the gas install the delivered molecular sieve. **A** with another green marked tube.

The picture shows an example of a molecular sieve.

7

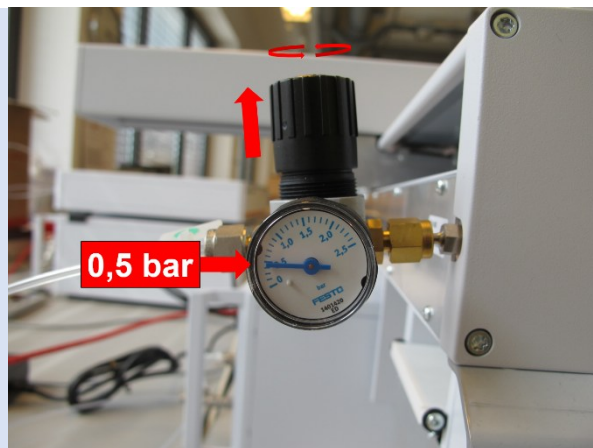

Pull the button to unlock.

Set the purge gas pressure to 0,5 bar.
Press the button to lock

8

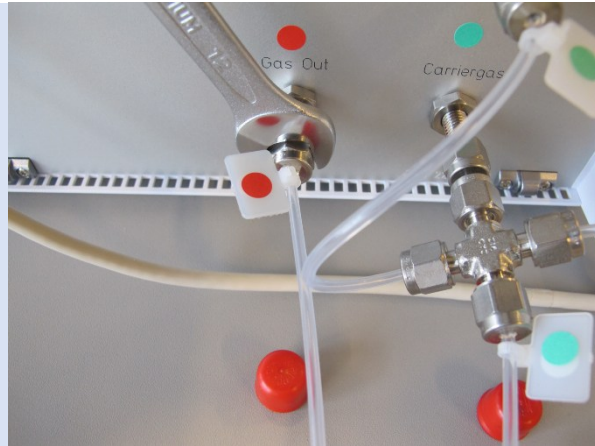

Connect a waste tube (red marking) with 3 mm Swagelok-connection to the Gas out-connection using a 12 mm spanner.

Connect the other end of the tube to an adequate laboratory waste system.

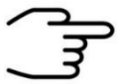

INFORMATION!

Only use stainless steel pressure reducer, PTFE tubes with 3 mm outer diameter and 3 mm swagelok connectors.

To ensure a high purity of the gas install the provided moisture trap.

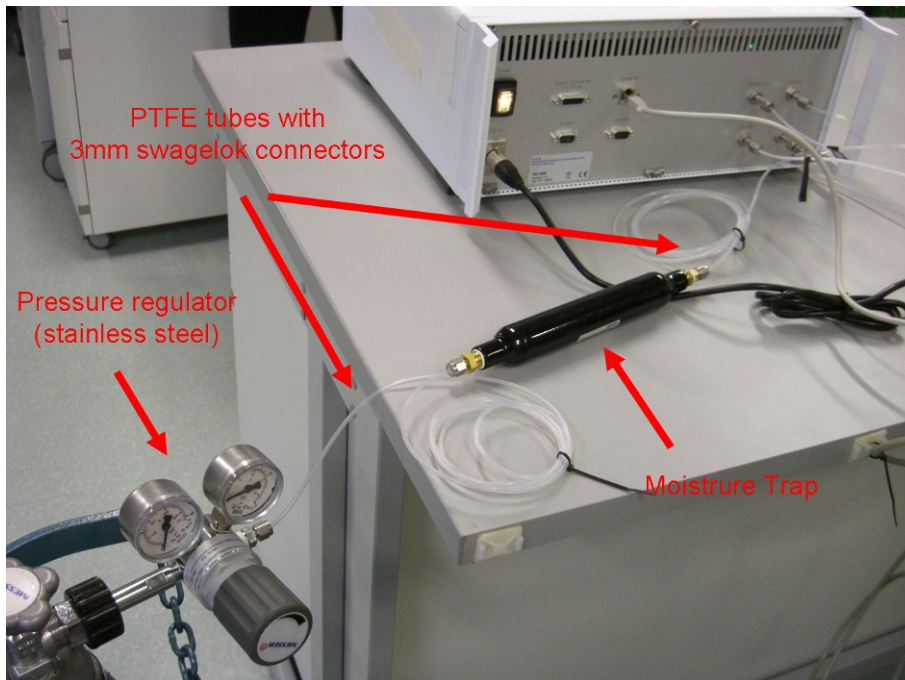

Figure 2: Gas supply installation

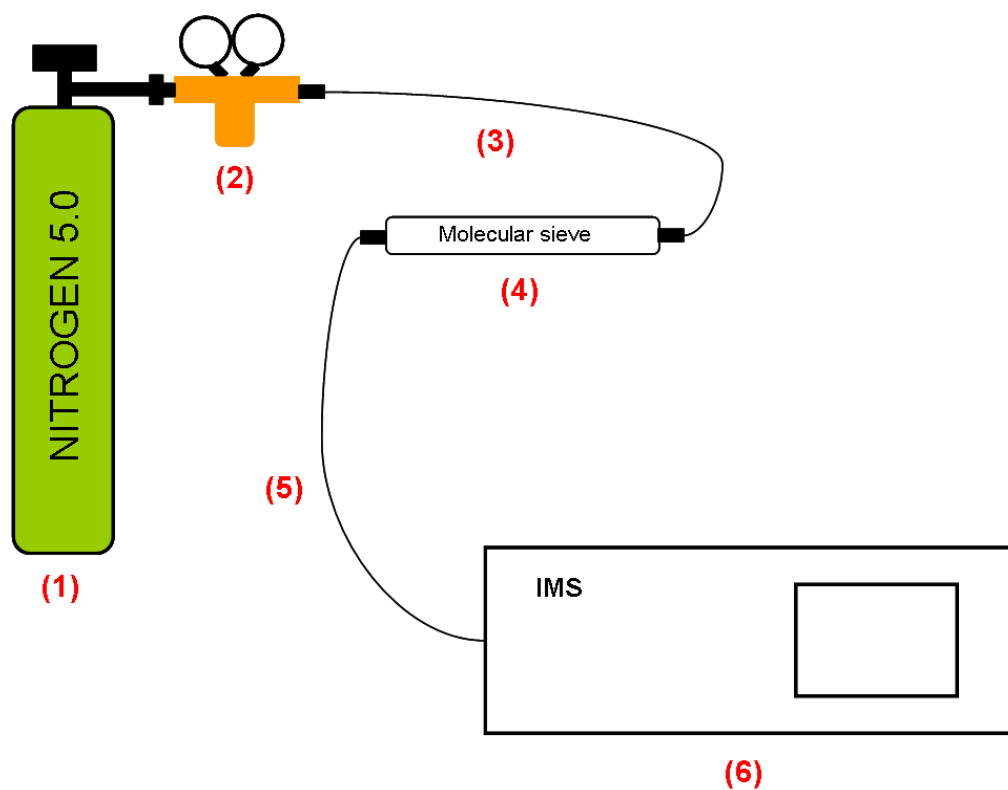
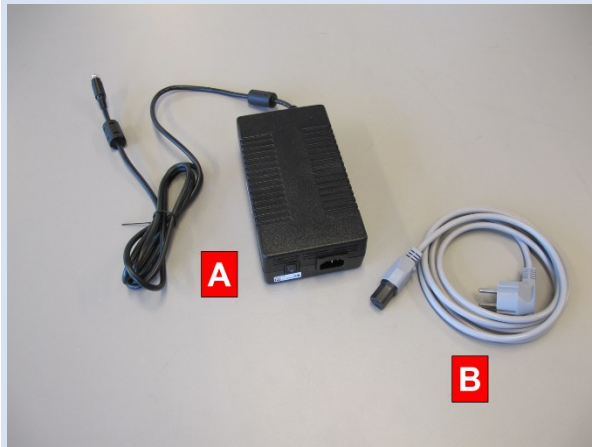

Figure 3: Gas supply installation (schematic)

1	Gas supply e.g. gas bottle with Nitrogen 5.0 (<i>provided by customer</i>)
2	Pressure reducer (<i>provided by customer</i>)
3	2 m PFA gas tube with 3 mm Swagelock connector (<i>provided by G.A.S.</i>)
4	Molecular sieve with 3 mm connection (<i>provided by G.A.S.</i>)
5	2 m PFA gas tube with 3 mm Swagelock connector (<i>provided by G.A.S.</i>)
6	Device (<i>provided by G.A.S.</i>)

5.8 Connect the Power Supply

1



Power supply

Autosampler:

A: PAL RSI Autosampler Power Supply

B: Country-specific Power Plug

2

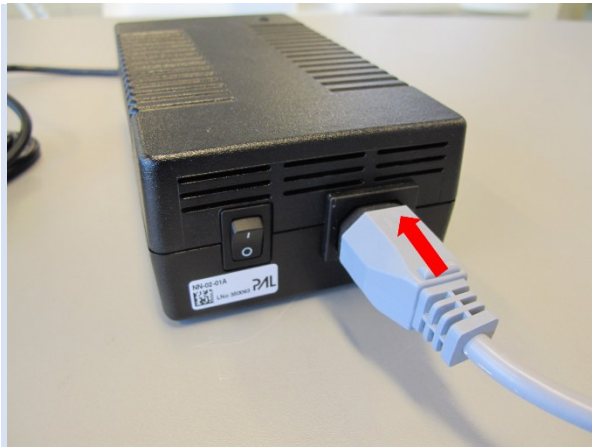

Connect the Power supply unit with the power plug.

Connect the power plug to a power supply.

3



Connect the power plug to the power connector at the rear of the Autosampler (red marking).

4

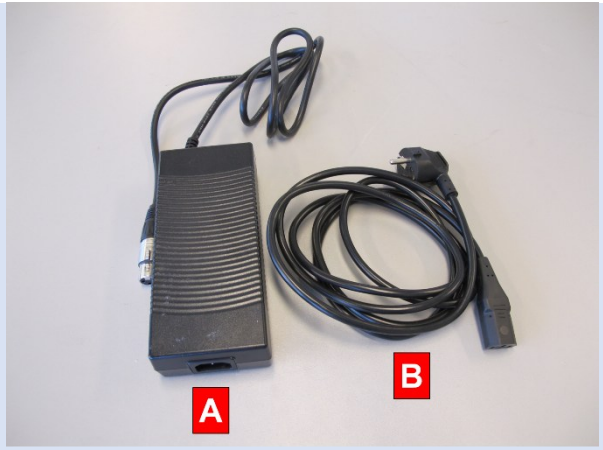

Power Supply
FlavourSpec:
A: FlavourSpec Power Supply
B: Country-specific Power Plug

5



Connect the Power supply unit with the power plug.

Connect the power plug to a power supply.

6



Connect the power plug to the power connector at the rear of the FlavourSpec (red marking).

5.9 Remove the Transport Lock

1



Transport Lock Sign at the front of the autosampler.

2

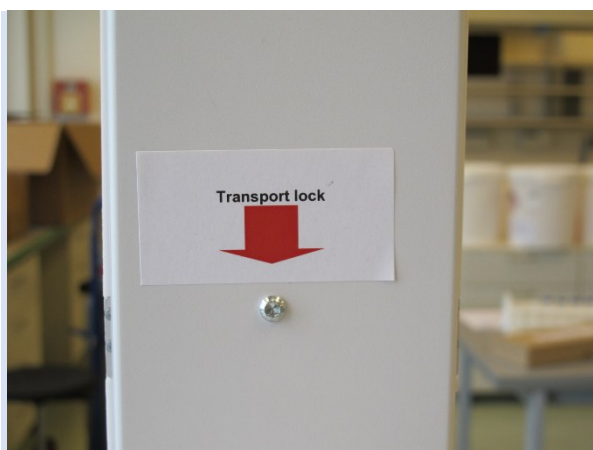

Transport Lock Sign at the rear of the autosampler.

3

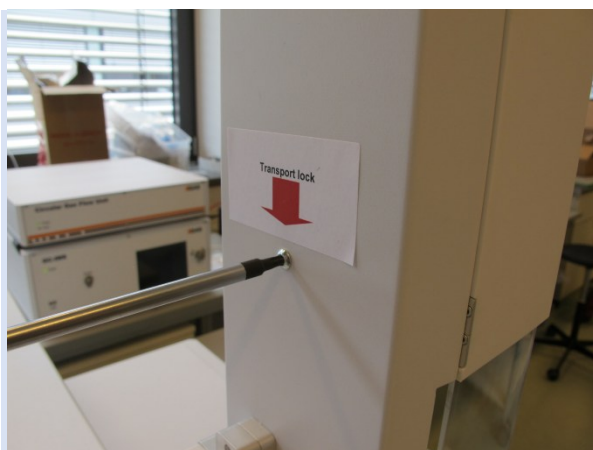

Remove the transport lock screw with a screwdriver (Torx T20).

Keep the screw for future use.

5.10 Complete the Device

1

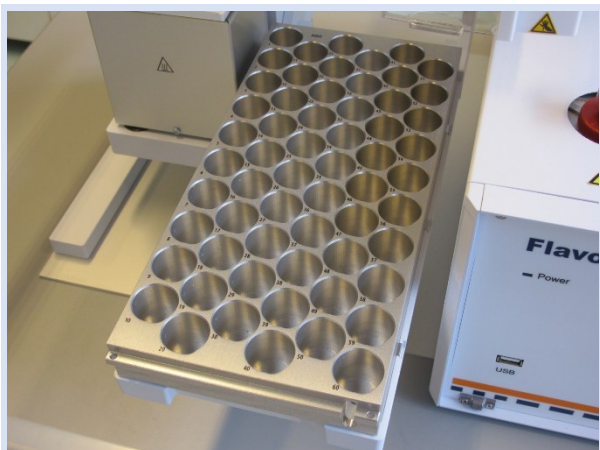

Place the tray to the trayholder.

5.11 Switch on the Device

1



Switch on PAL RSI Autosampler.

2



Switch on the FlavourSpec.



INFORMATION!

For detailed information concerning the autosampler please refer the autosampler manual.

5.12 Check essential device postion

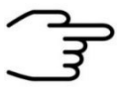

Before working with the instrument the position of the injector, agitator and the trayholder must be tested and if necessary adapted.

1

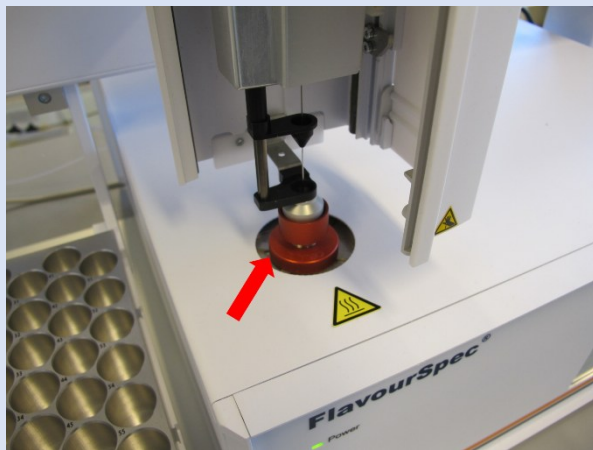

Check the position of the injector (see chapter 6.2)

OPTIONAL

Teach the position of the injector (see [FlavourSpec User Manual](#))

2

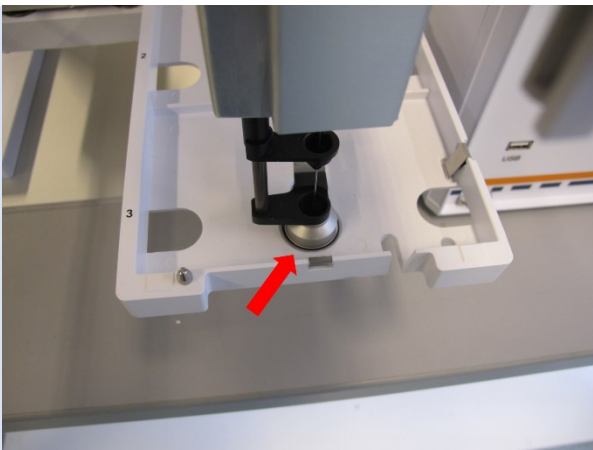

Check the position of the trayholder (see chapter 6.4)

OPTIONAL

Teach the position of the trayholder (see [FlavourSpec User Manual](#))

Check the position of the agitator (see chapter 6.3)

3



OPTIONAL

Teach the position of the agitator (see [FlavourSpec User Manual](#))

5.13 Prepare the device for operation

Before using the device for the first time or after being disconnected from the nitrogen source for some time it must be cleaned to ensure proper operating conditions. In this case start the **cleaning mode**.

An appropriate cleaning period duration must be chosen depending on how long the device was switched off and on the extent of contamination. It is recommended to clean the device for at least **15 hours** before operating it for the first time. If the Spectrum is not clean repeat the process. A **reference spectrum** for the evaluation can be found in the supplied **Analytical Approval**.



INFORMATION!

After the cleaning process the device needs at least **2 hours** to cool down the internal components to their required temperatures.

The duration of the cool down process is depending on the temperature default settings.

1

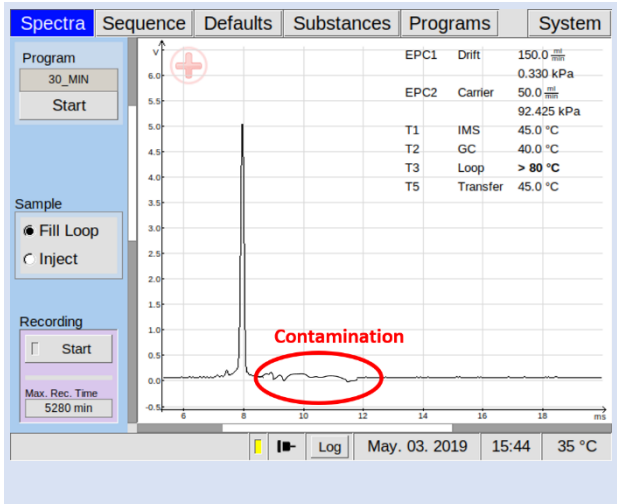

Inspect spectrum for contamination. Control the baseline. Start cleaning when contaminated. Contamination is indicated by peaks or the disappearing of the RIP.

2
Option

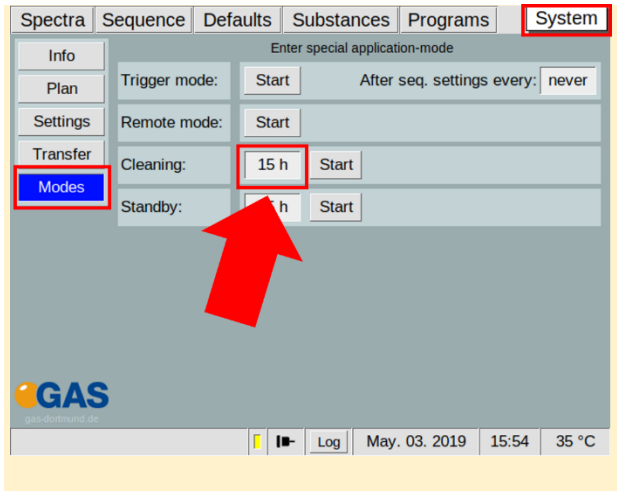

Select duration in hours:
System > **Modes** > **Cleaning Mode** > **x h**

3
Option

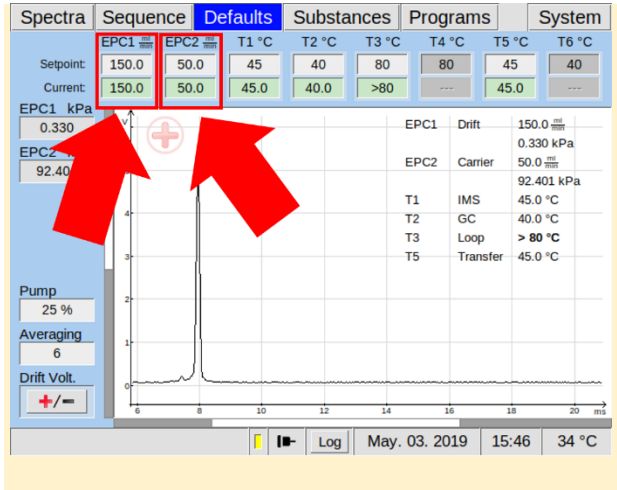

To speed up this process, increase flow rate of EPC1 and EPC2 to their maximum values (e.g 500/150 ml/min):
Defaults > **EPC1** > **EPC2**

4

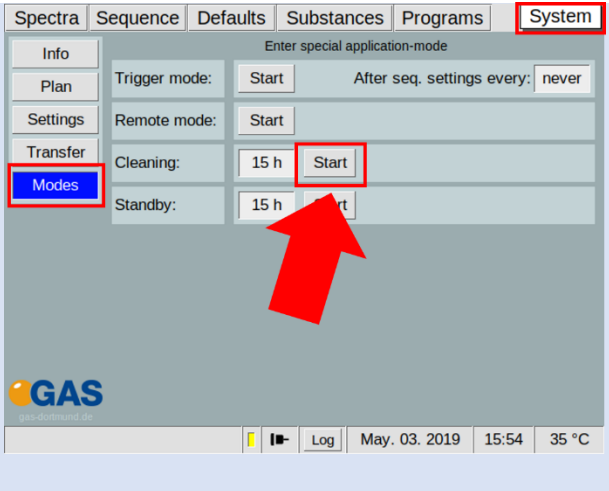

Start cleaning:

System > Modes > Cleaning Mode > Start

5

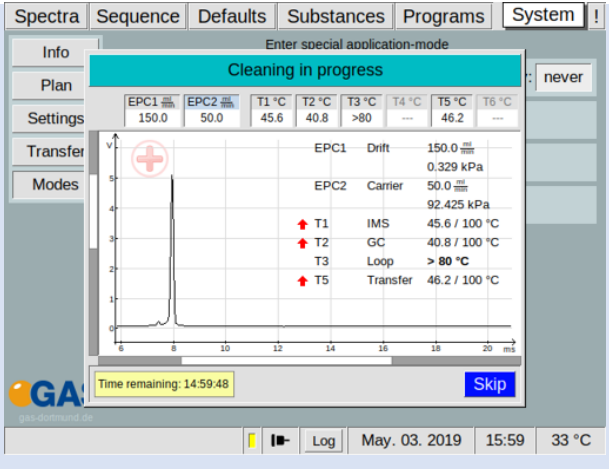

Wait until cleaning process is completed. The process can be stopped with Skip.

6

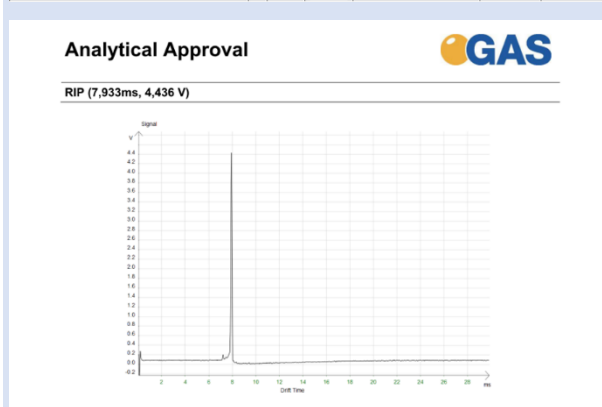
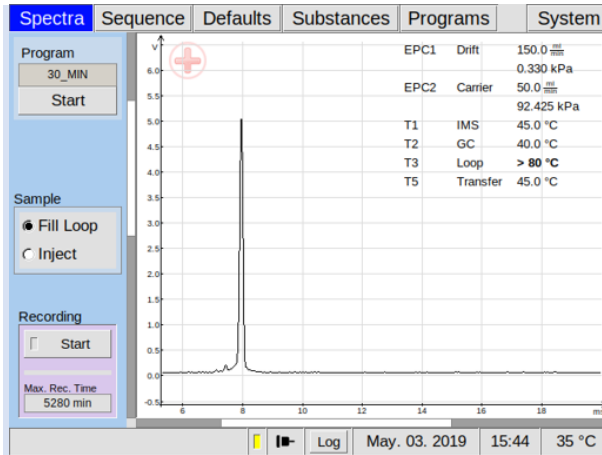

After all temperatures reached the default values inspect visually the current spectrum and compare it with the reference spectrum of the analytical approval. **The RIP should reach ~80% of the RIP height displayed in the delivered Analytical Approval of the device under same measurement conditions of G.A.S. The assessment of the readiness to measure is additionally supported by the system.**

If not check the gas quality and/or install additional purification cartridges and start the cleaning procedure again.



INFORMATION!

The device is delivered with an acceptance snapshot. This snapshot defines the system performance during device acceptance and is used to assess the readiness for measurement. Any deviations from this are displayed in the Error Information Window. **The default values can be adjusted by the customer.**

6 System Operation

6.1 Measurement Requirements



INFORMATION!

Only use the original accessories supplied with the device.



INFORMATION!

Make sure that the gas quality is 5.0 (99,999%) or better.



INFORMATION!

Only use stainless steel pressure reducer.



INFORMATION!

Make sure that the spectrum is clean a without contamination.



WARNING!

Do not introduce any liquids. This can destroy the device.



INFORMATION!

Make sure that that all temperature-, flow- and pressure values have reached their default value and are stabilized.

6.2 Workflow: Check Injector Position



INFORMATION!

It is recommended to check the position of the injector after every transport of the device. A false position can damage the syringe. When using the Headspace-Tool it is recommended to use the Injector Adapter.

1

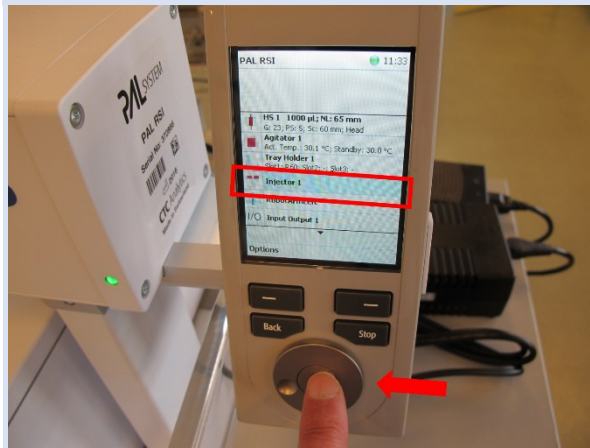

On the PAL RSI main screen select **Injector 1**.

2

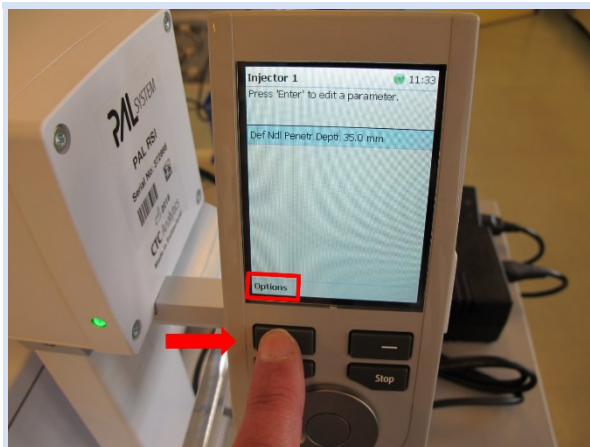

With the **left function key** select **Options**.

FlavourSpec®25 - Quickstart Manual

3

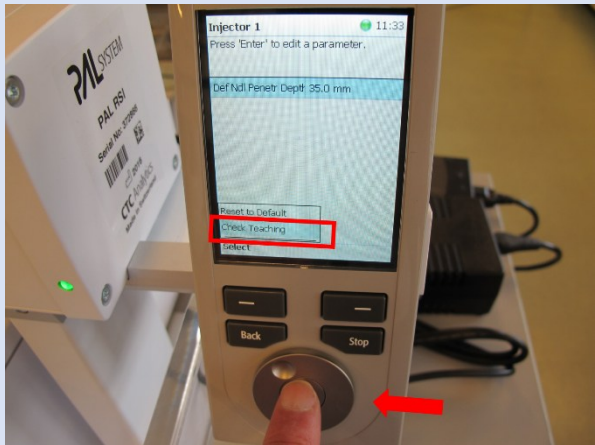

In options menu select **Check Teaching**.

4



With the right function key select **Check**.

5

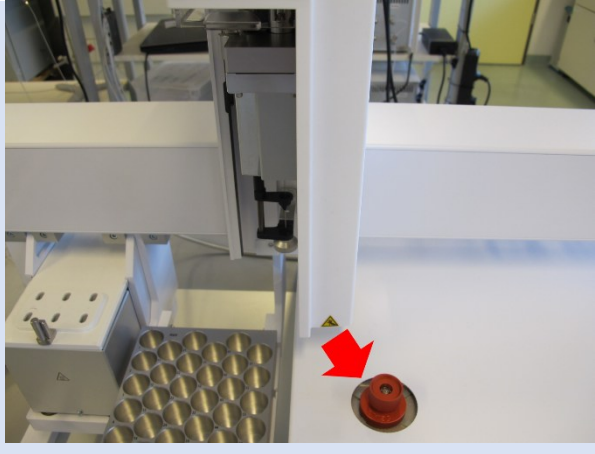

After a warning signal the arm moves to actual injector position.

6

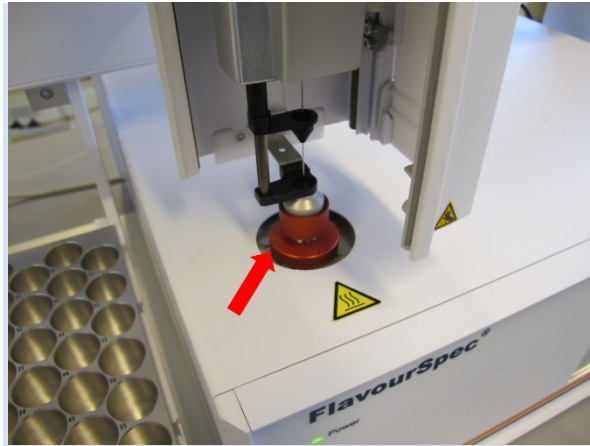

The magnetic adapter of the tool and the injector adapter has to fit. Otherwise the injector position must be taught (see FlavourSpec User Manual)

7

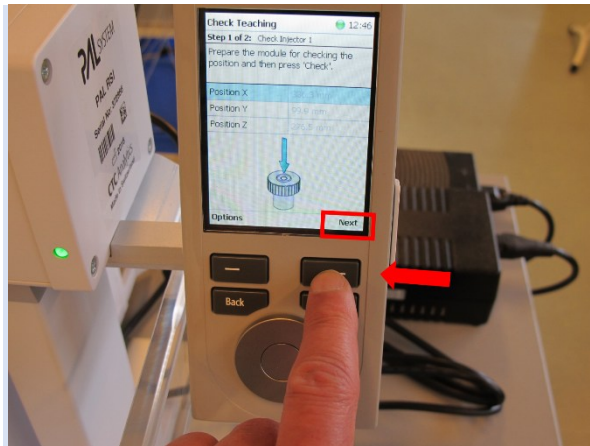

With the right function key select Next.

8



With the right function key select OK.

9

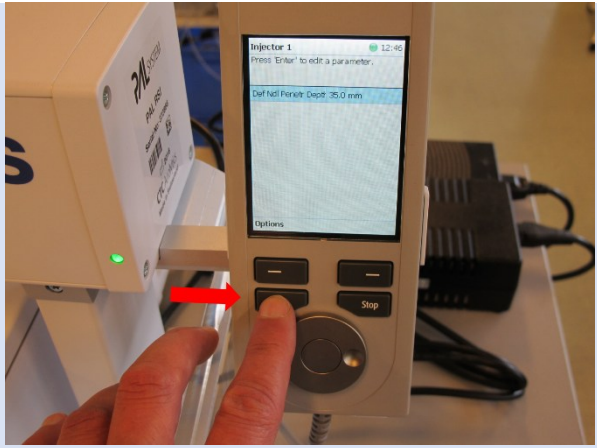

Select the **BACK-button** to go to the **main screen**.

6.3 Workflow: Check Agitator Position



INFORMATION!
It is recommended to check the position of the agitator after every transport of the device.

1

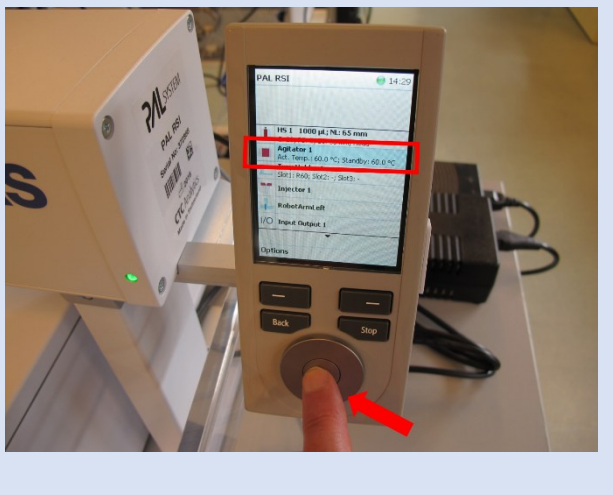

On the **PAL RSI main screen** select **Agitator 1**.

2

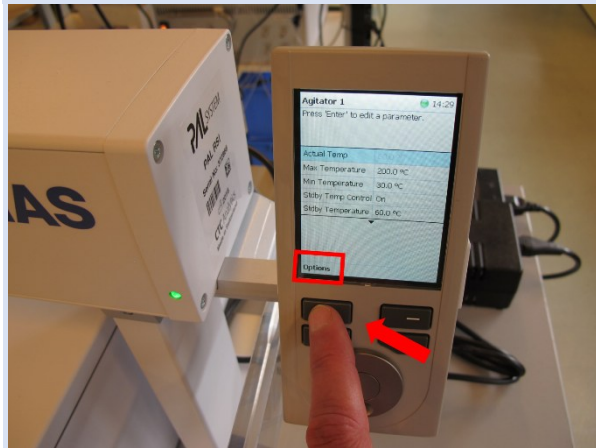

With the **left function key** select **Options**.

3

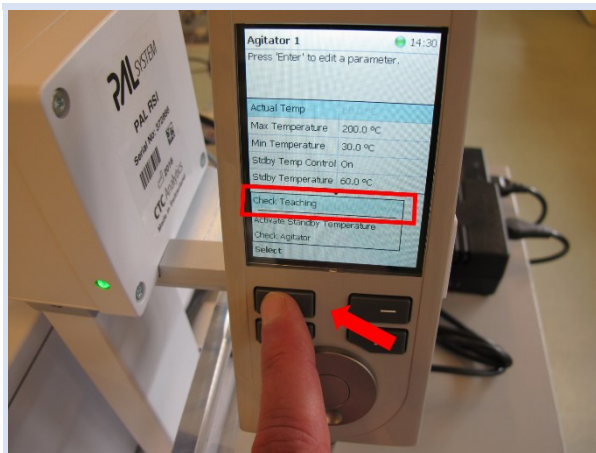

In **option menu** select **Check Teaching**

4

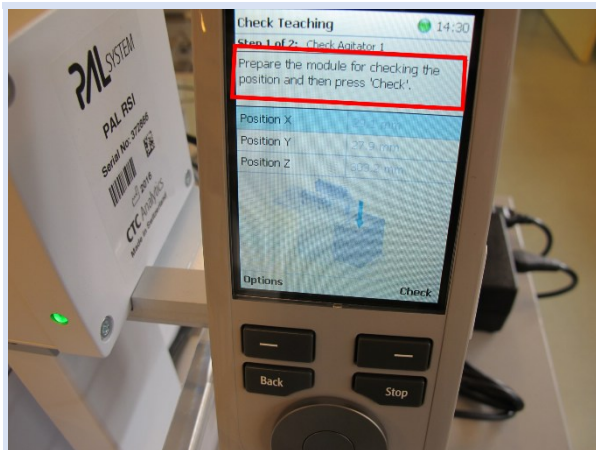

Follow the instruction on the screen:
Prepare the module...

5

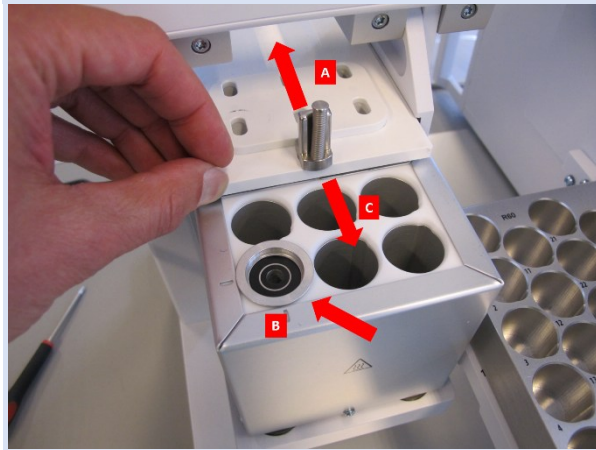

Move the cover back **A**, insert the teaching tool in position 1 **B** and close the cover **C**.

6



With the **right function key** select **Check**.

7

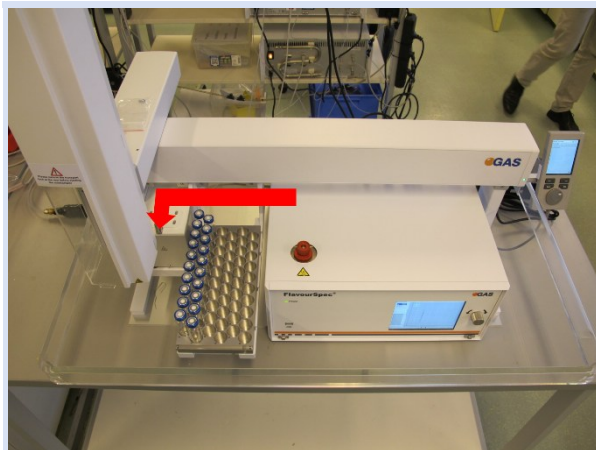

After a **warning signal** the **arm moves** to the actual agitator position.

8

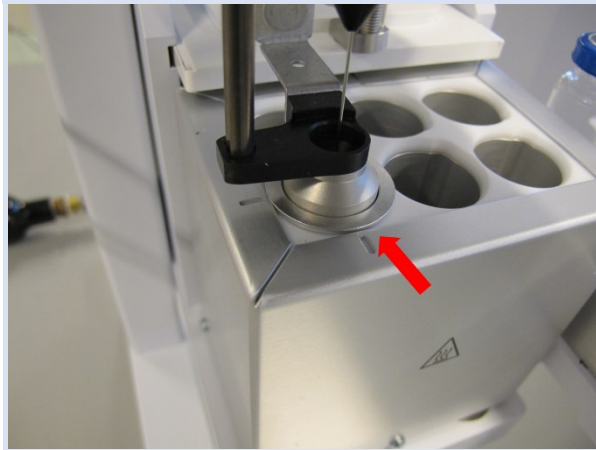

The magnetic adapter of the tool and the teaching tool has to fit. Otherwise the agitator position must be taught. (see [FlavourSpec User Manual](#))

9

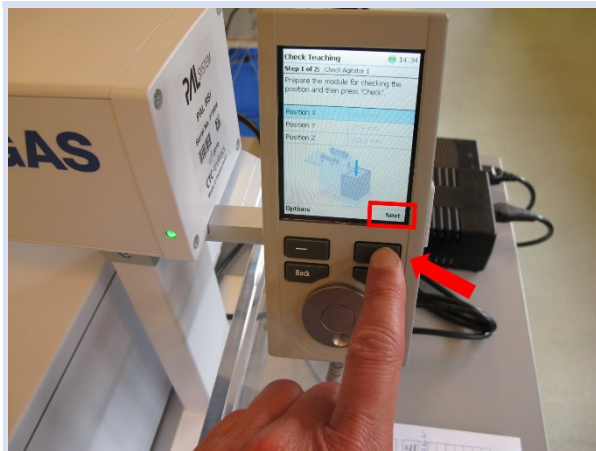

With the **right function key** select **Next**.

10

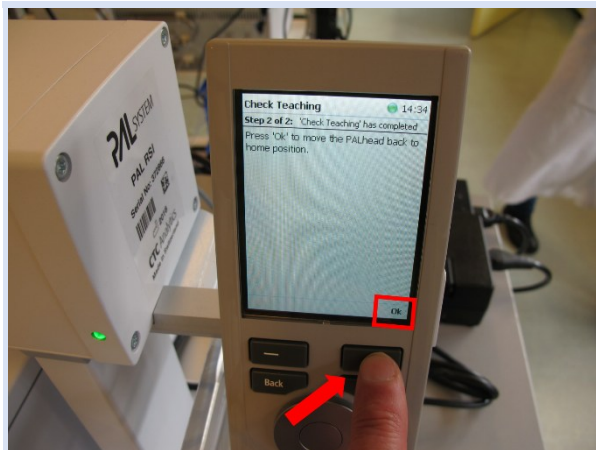

With the **right function key** select **OK**.

11



Select the **Back button** to go to the **main screen**.

6.4 Workflow: Check Tray Reference Position



INFORMATION!
It is recommended to check the position of the agitator after every transport of the device. A false position can damage the syringe.

1

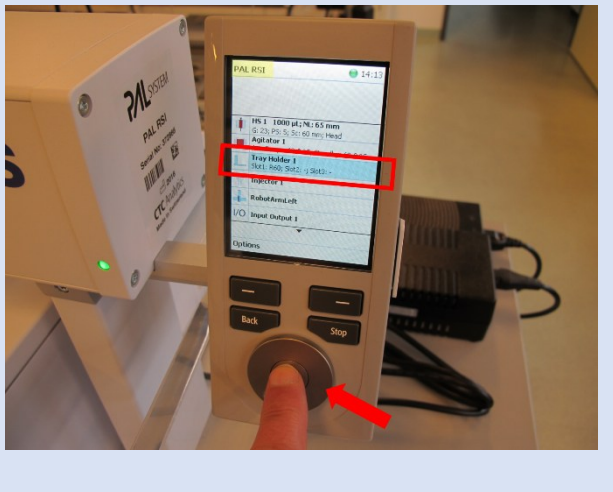

On the PAL RSI main screen select **TrayHolder 1**.

2

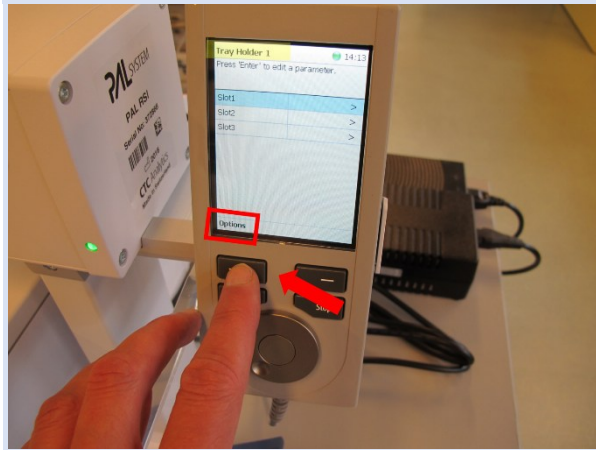

With the **left function key** select **Options**.

3

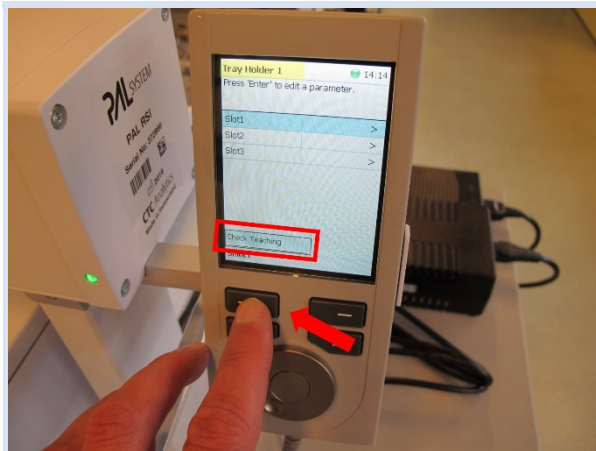

In **options menu** select **Check Teaching**.

4

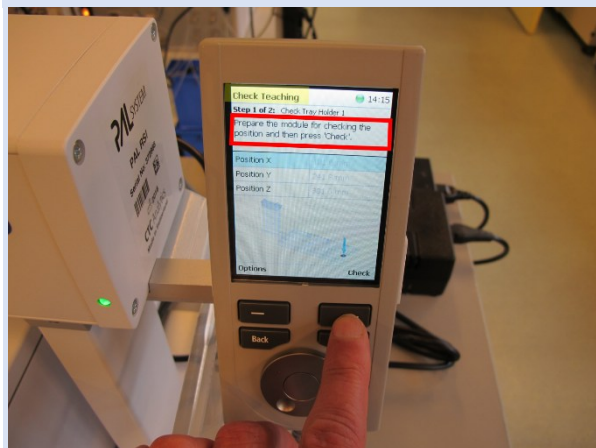

Follow the instruction on the screen:
Prepare the module...

5

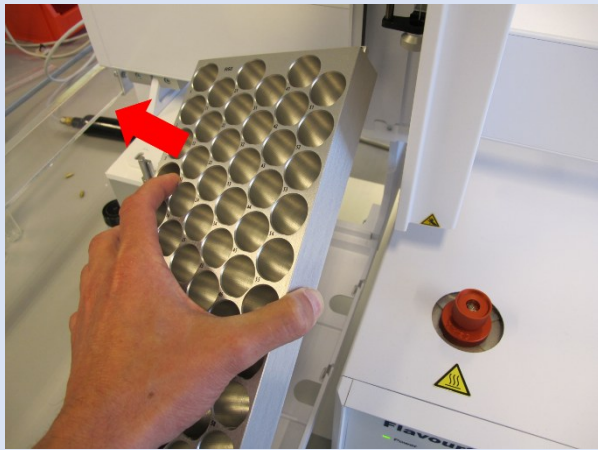

Remove the tray.

6

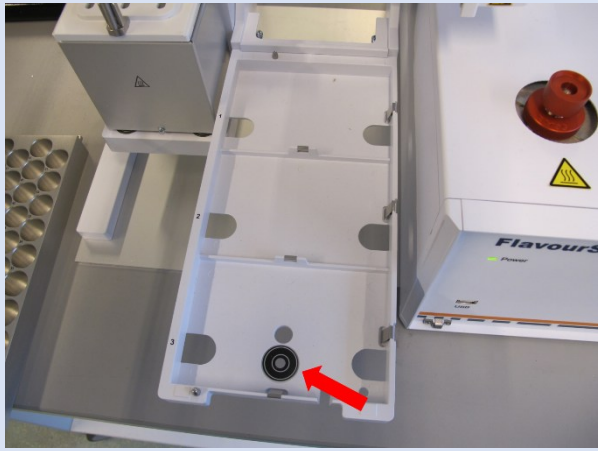

The figure shows the teaching point of the tray holder.

7

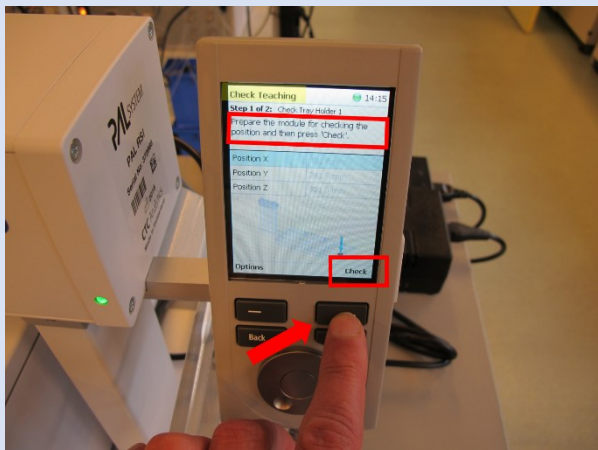

With the **right function key** select **Check**.

8

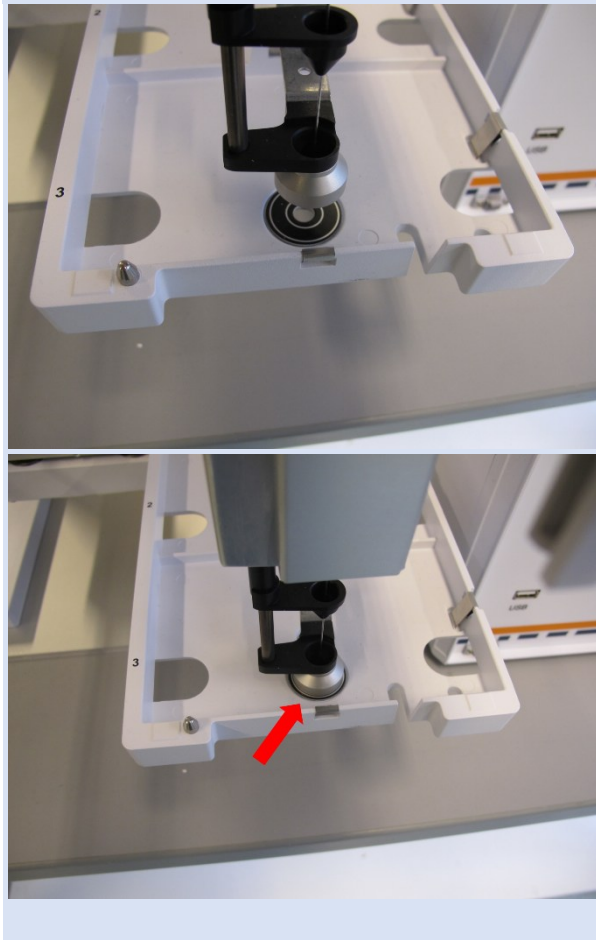

After a **warning signal** the **arm moves** to the actual teaching point.

The magnetic adapter of the tool and the teaching point has to fit. Otherwise the tray reference position must be taught. (see

FlavourSpec User Manual)

9



With the **right function**

key select **Next**.

10

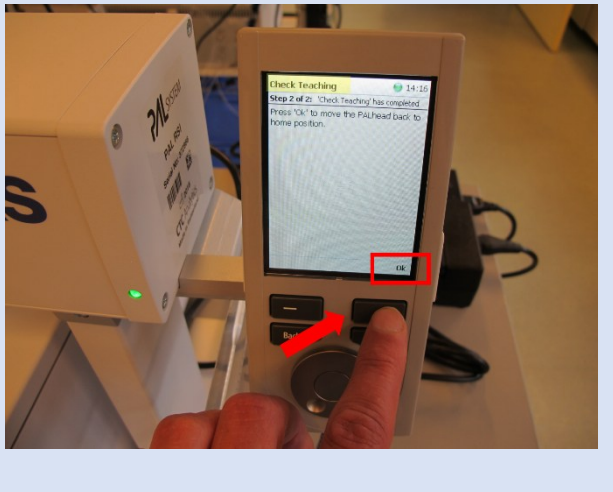

With the **right function key** select **OK**.

11

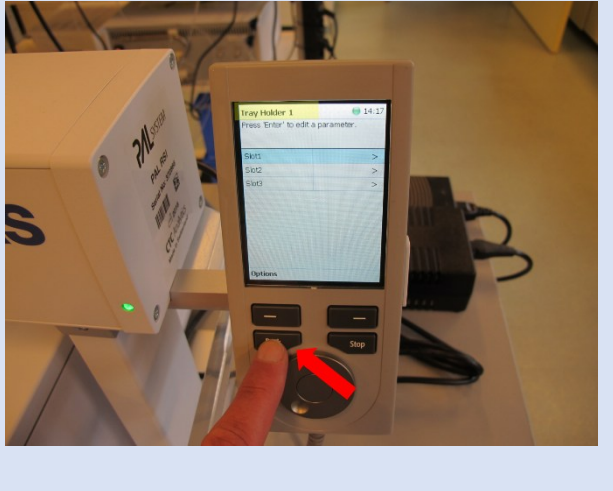

Select the **Back button** to go to the **main screen**.

6.5 Workflow: Run a measurement with autosampler



INFORMATION!
To run measurements with an autosampler the following steps are required.

1

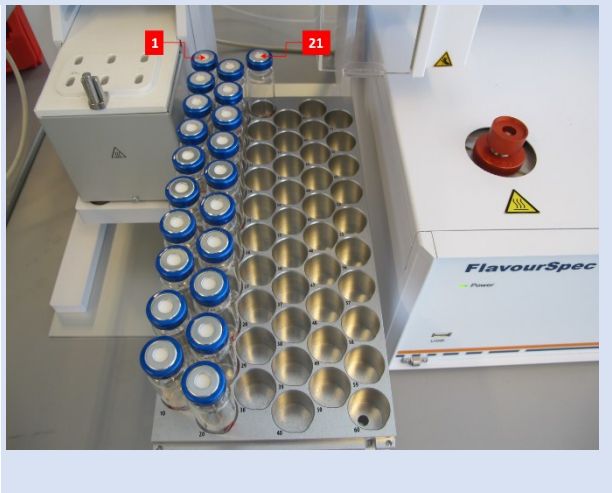

Put the sample into the tray.

2

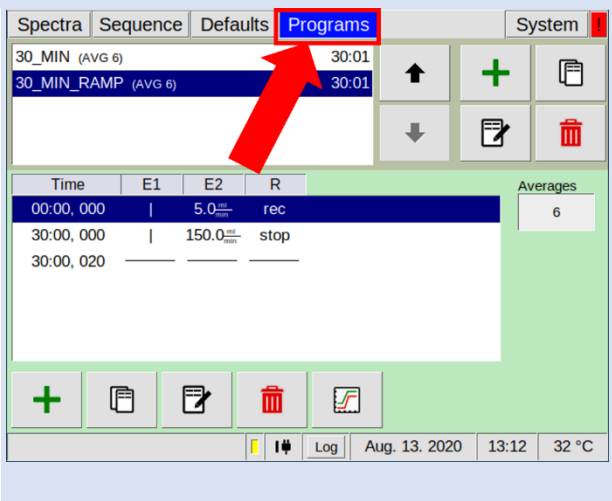

Create a measurement program or select one (see [FlavourSpec User Manual](#))
The start values for E1 and E2 must correspond...

3

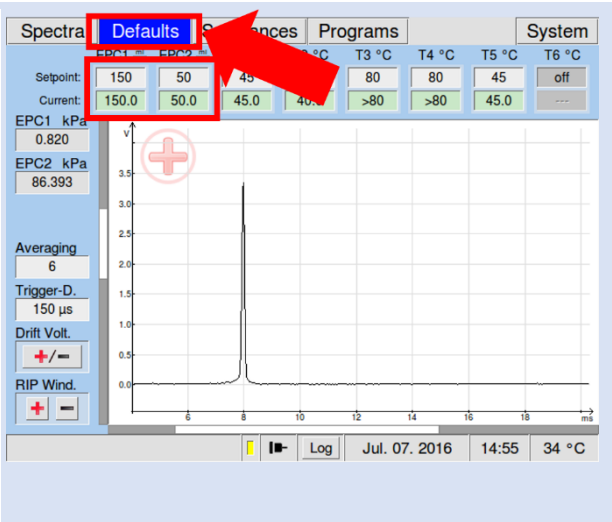

...to the values for EPC1 and EPC2 in Defaults window.

4

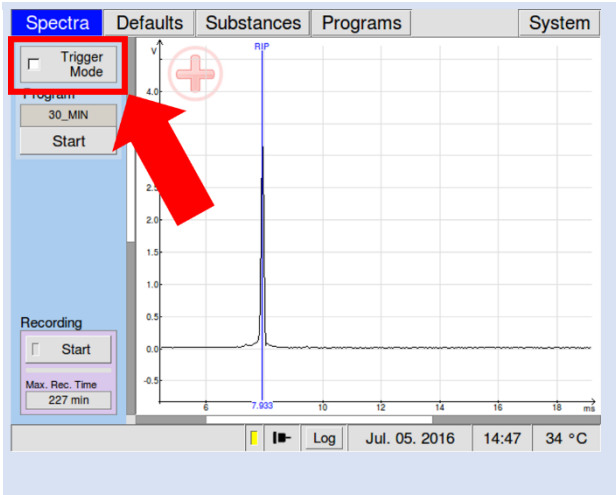

In **spectra window** select **Trigger mode**.

5

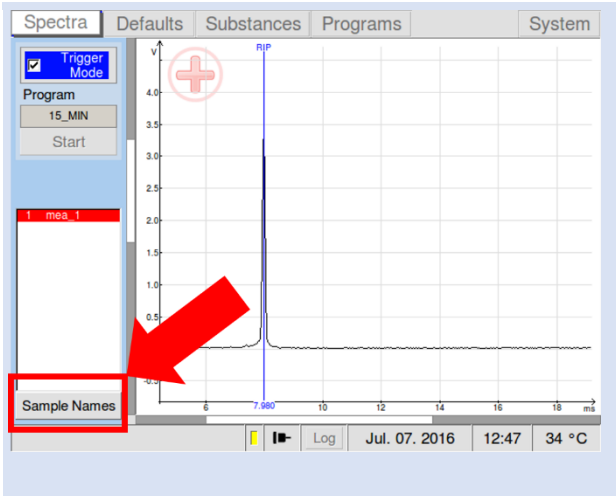

Select Sample Names.

6

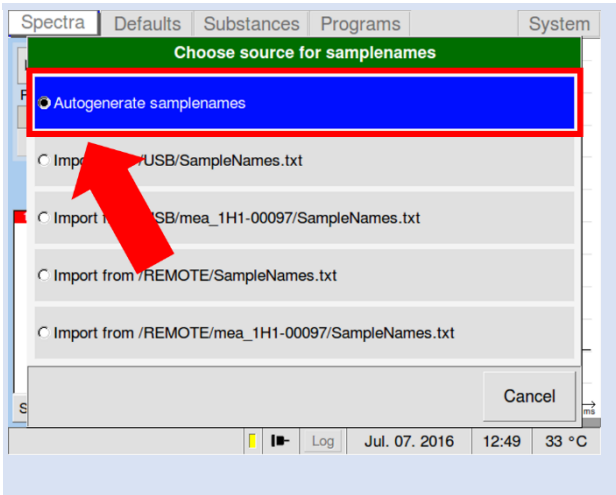

To generate an automatic samplelist select autogenerate samplelist.

7

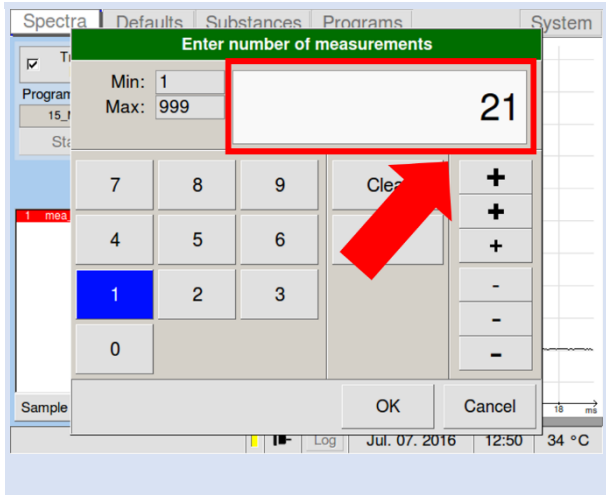

Enter the number of samples.

8

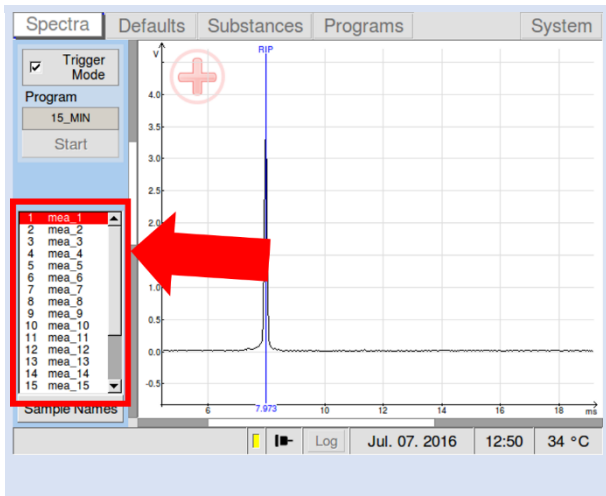

The actual samplelist is shown.

9

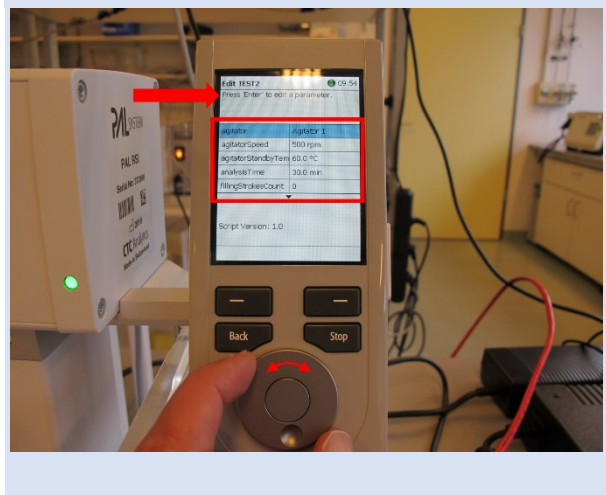

Create a new method or edit a method (see [FlavourSpec User Manual](#))

10

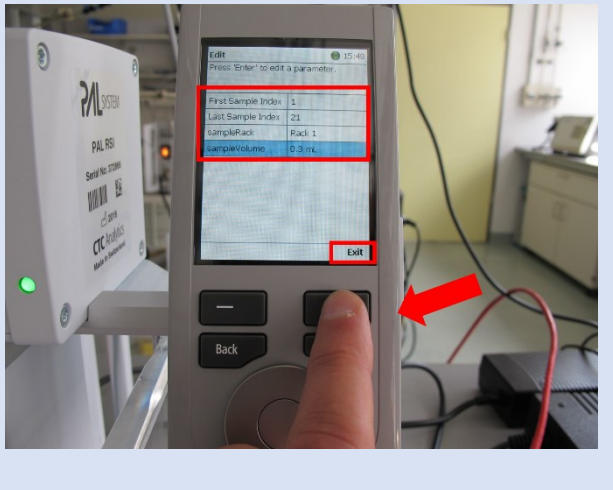

Create a new job or edit a job (see [FlavourSpec User Manual](#))
Enter the number of samples.

11

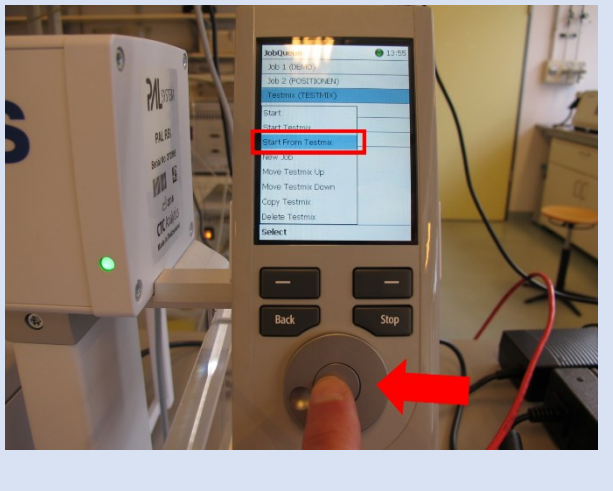

Select the job and start.

12

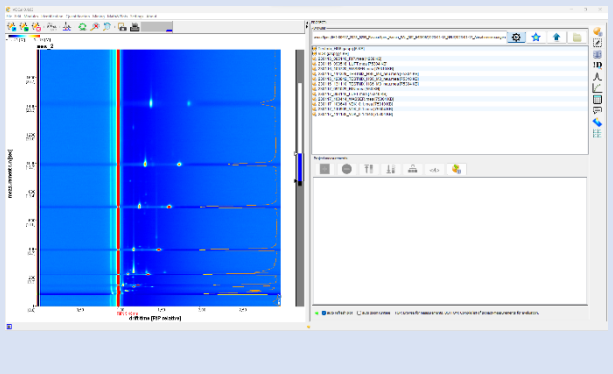

View and analyze the measurement files with the VOCAL software.



INFORMATION!
For detailed information about the VOCAL software refer the VOCAL Software Manuals and Tutorials

6.6 Workflow: Run a measurement with manual injection

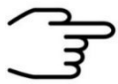

INFORMATION!
 Measurements can also be done without autosampler. The headspace-sample must be inject manually and the device has to be start manually too.

1



Put the sample into the tray.

2

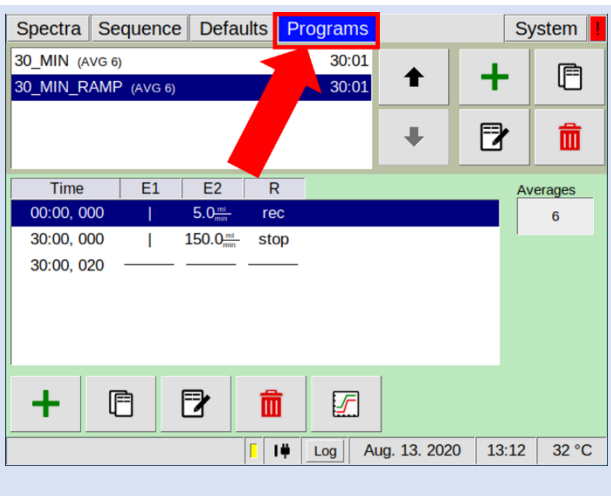

Create a measurement program or select one (see **FlavourSpec User Manual**)
 The start values for E1 and E2 must correspond...

3

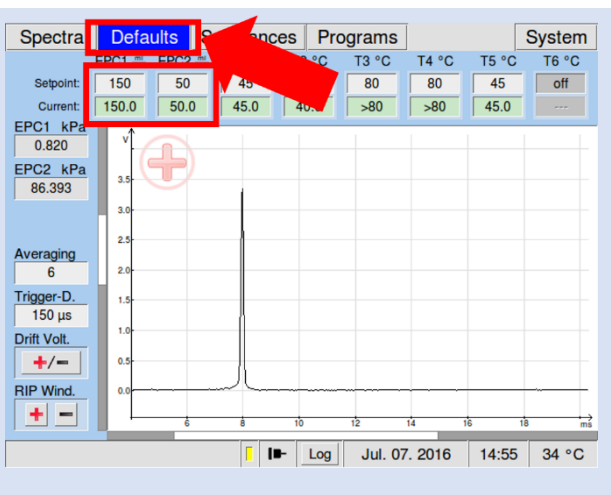

...to the values for EPC1 and EPC2 in **Defaults window**.

4

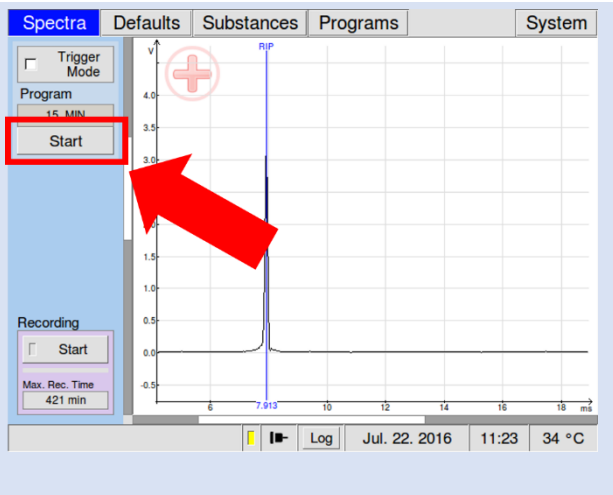

Go to **Spectra window** and **press start**.

5

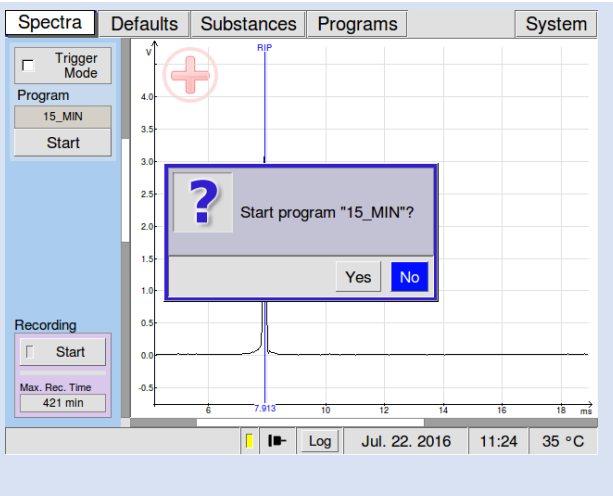

An information windows appears.

6

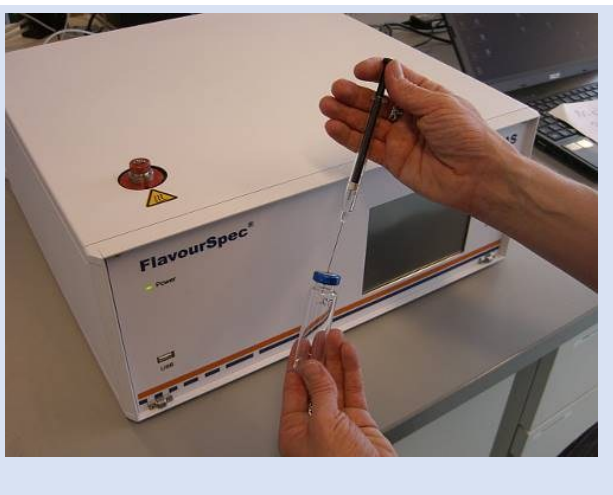

Select the headspace sample with a proper gastight syringe.

7

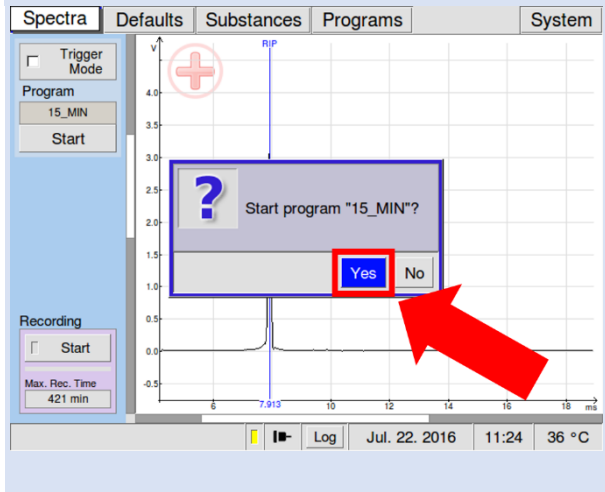

Select **YES** in the information window.

8

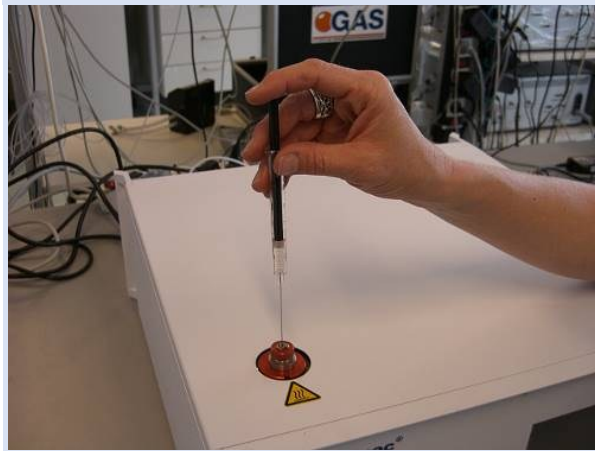

Inject the headspace sample into the sample injector port.

12

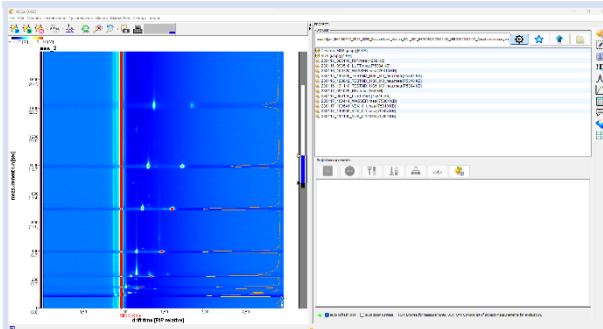

View and analyze the measurement files with the VOCAL software.







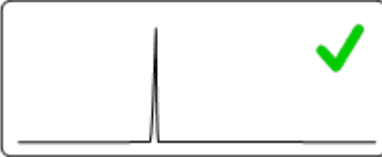
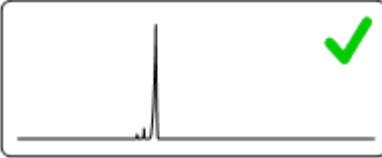

INFORMATION!

For detailed information about the VOCAL software refer the VOCAL Software Manuals and Tutorials

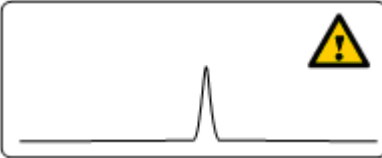
7 Appendix

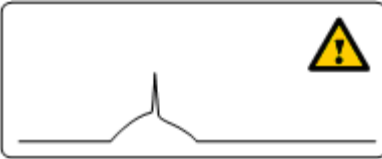
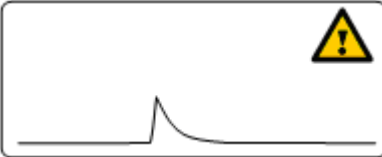
7.1.1 IMS-Spectrum Examples

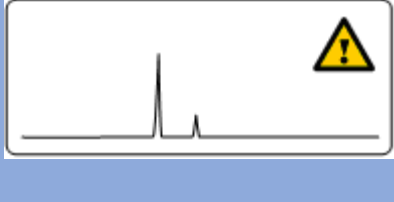
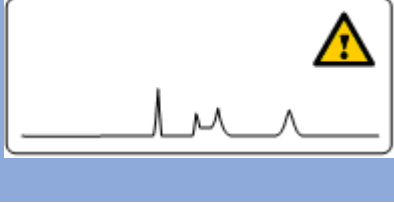
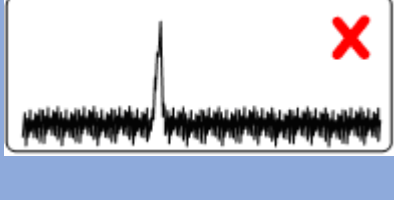
Schematic of IMS spectrum	Spectrum description	reasons / suggestions
	Clean spectrum	Perfect
	Clean spectrum, up to two extra signals left hand side of the RIP	Perfect
	RIP shifted to lower drift times	<ul style="list-style-type: none"> - elevated temperature - reduced pressure
	RIP shifted to higher drift times	<ul style="list-style-type: none"> - low temperatures - elevated pressure
	RIP deformed	<ul style="list-style-type: none"> - gas quality out of specifications - device needs to be flushed for some time - flows not in range
	RIP base deformed yet visible	<ul style="list-style-type: none"> - gas quality out of specifications - device needs to be flushed for some time - flows not in range
	RIP deformed towards tailing	<ul style="list-style-type: none"> - gas quality out of specifications - device needs to be flushed for some time - flows not in range

	<p>Minor impurities</p>	<ul style="list-style-type: none"> - gas quality out of specifications - device is polluted > run system cleaning
	<p>Major impurities</p>	<ul style="list-style-type: none"> - gas quality out of specifications - device is polluted > run system cleaning
	<p>Elevated noise</p>	<p>Contact G.A.S. support</p>
	<p>No signal</p>	<p>Contact G.A.S. support</p>

7.2 Corresponding G.A.S. Documents and Tutorials



INFORMATION!

- FlavourSpec User Manual
- PAL3 System User Manual
- Sequence Designer Manual
- IMS Control TFTP-Server Manual
- Tutorials Sequence Designer
- Tutorials VOCal
- Manuals VOCal